

Hawa Folding Concepta III

木质折叠回旋门

给您更多设计自由

旋转门板, 然后滑到旁边的停放区, 最后停放在最小的空间内:

这是Hawa Concepta III 家族成员如何使完整的橱柜和厨房单元消失并再次出现的秘诀。现在, Folding Concepta III 通过先折叠门板这个形式, 拓展了回旋门的运行顺序。

这个创新为大面积空间的利用提供了便利, 因为2折叠的门板可以使柜体面板达到3000mm宽, 2700mm高。运行机制和所有Concepta III系统一样简便: 轻轻一按, 就能打开门板, 然后启动后续的运行机制——所有的门板的滑行几乎是自动的。





Folding Concepta III 同时拥有五金产品特有的高品质: 有带和不带拉手的版本, 高度和宽度多变, 高度预组装——确保您工作, 生活和享受生活。



应用场景

追求功能多变, 弹性分割的空间, 如: 家庭办公区、开放式厨房, 以及步入式多功能室和储物间。

产品亮点

-  **灵活** 轻松适应各种柜门尺寸, 可与Hawa Concepta III 相结合无需中竖板, 轻松实现两门、三门或四门设计, 为柜门设计增添无限可能
-  **高效** 配件高度预组装, 安装方便, 通过易于接近的调节点, 进行简便的调节
-  **舒适** 步入式结构无障碍通过, 一只手轻松打开和关闭门板
-  **美观** 适用带或不带拉手的结构
门板统一、齐平设计, 配上均匀的门缝, 轻松实现柜体隐藏

技术标准

-  门板重量 20/25kg
-  门板高度 1200-2700mm
-  门板宽度 440-750mm
-  门板厚度 18-26mm

选装配件

- 门板拉直器
- 顶板加固配件
- 底座支撑配件

安装示例

Hawa Folding Concepta III 20/25 Push

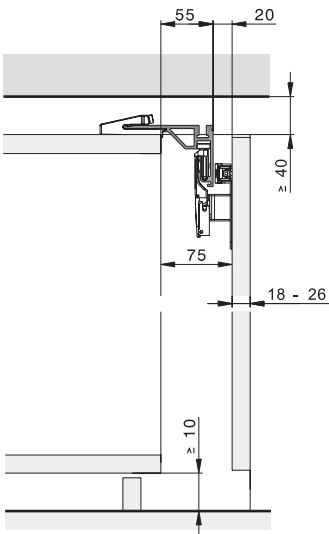

外盖门, 不带底部型材

Hawa Folding Concepta III 20/25 Push

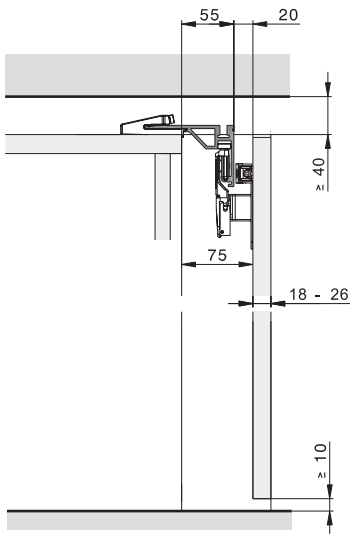

一门到顶无底板

Hawa Folding Concepta III 20/25 Pull

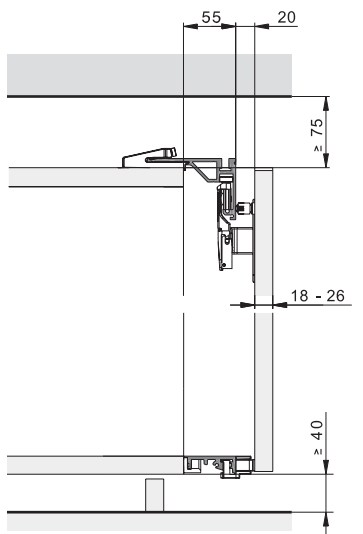

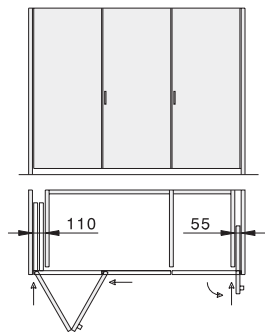
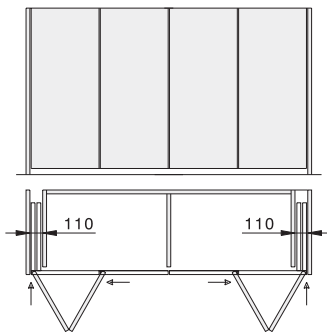
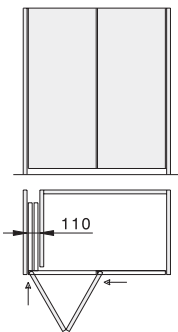

与Hawa concepta III 25/35 pull相结合的三门系统, 带底部型材





适用于20kg旋转推入式折叠木门的五金件。统一,齐平的门板设计搭配均匀的门缝。
推弹开启功能实现无拉手的柜体设计。

产品亮点

-  **灵活** 多种门板尺寸,适用于落地式、步入式衣柜,可搭配Hawa Concepta III
-  **高效** 得益于高度的预组装和简单的调节,安装更便捷
-  **美观** 无把手柜体设计 —— 隐藏设计带来整洁外观

技术标准

-  门板重量 6-20kg
-  门板高度 1200-2200mm
-  门板宽度 440-750mm
-  门板厚度 18-26mm

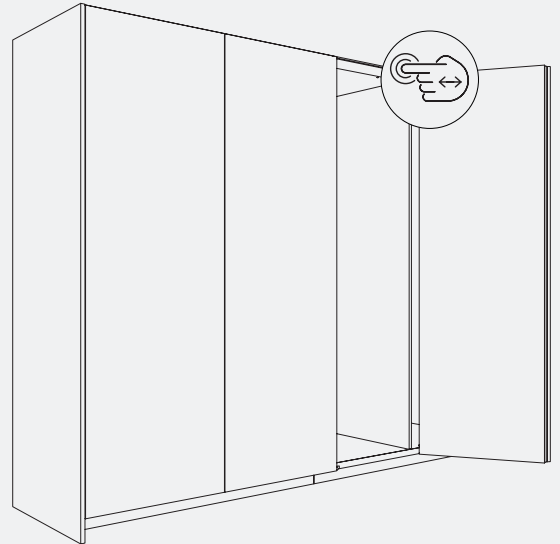

安装示例
外盖门,无底座型材

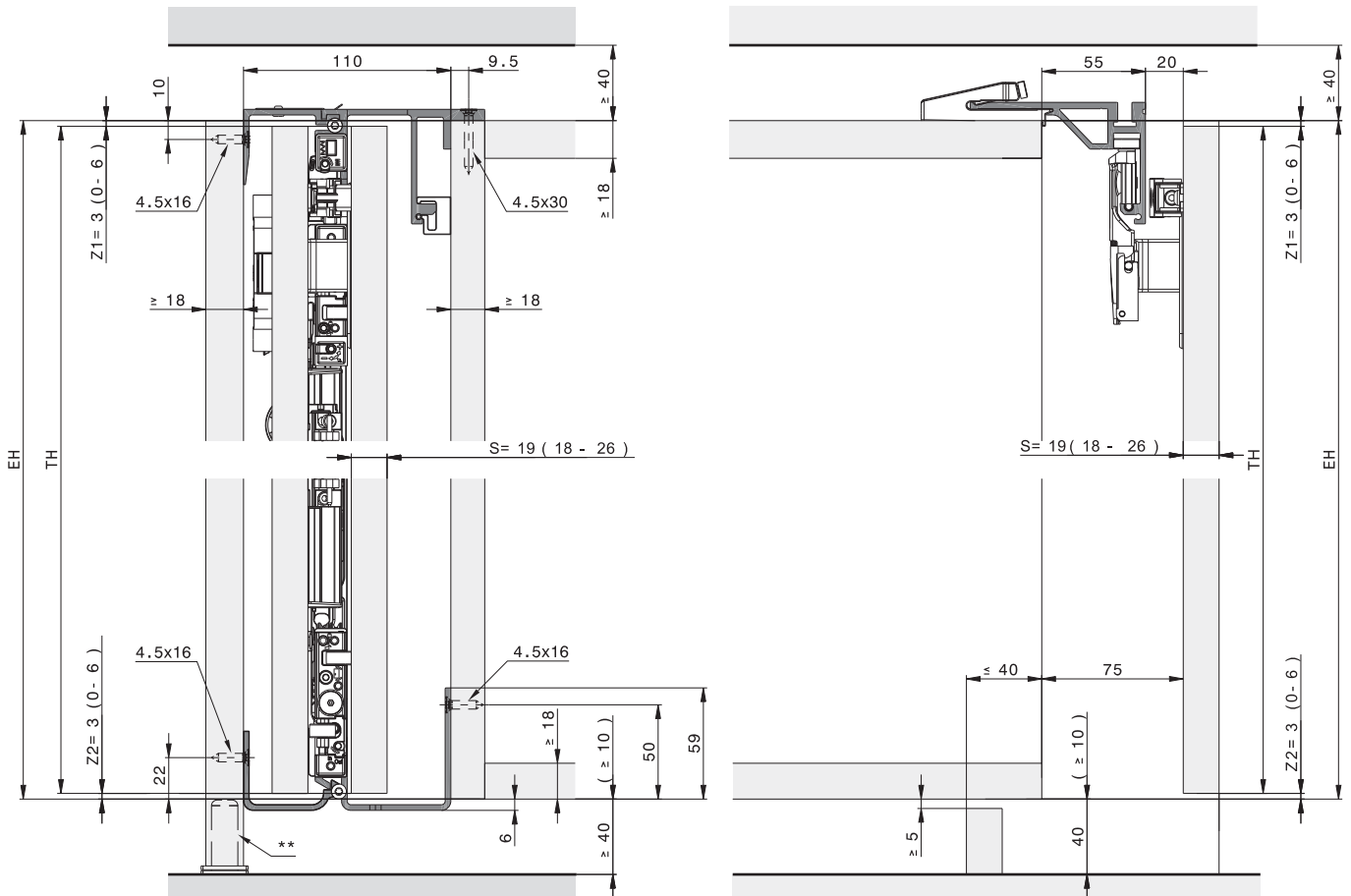

** 建议:使用调节脚

两门/四门系统外盖门, 无底座型材

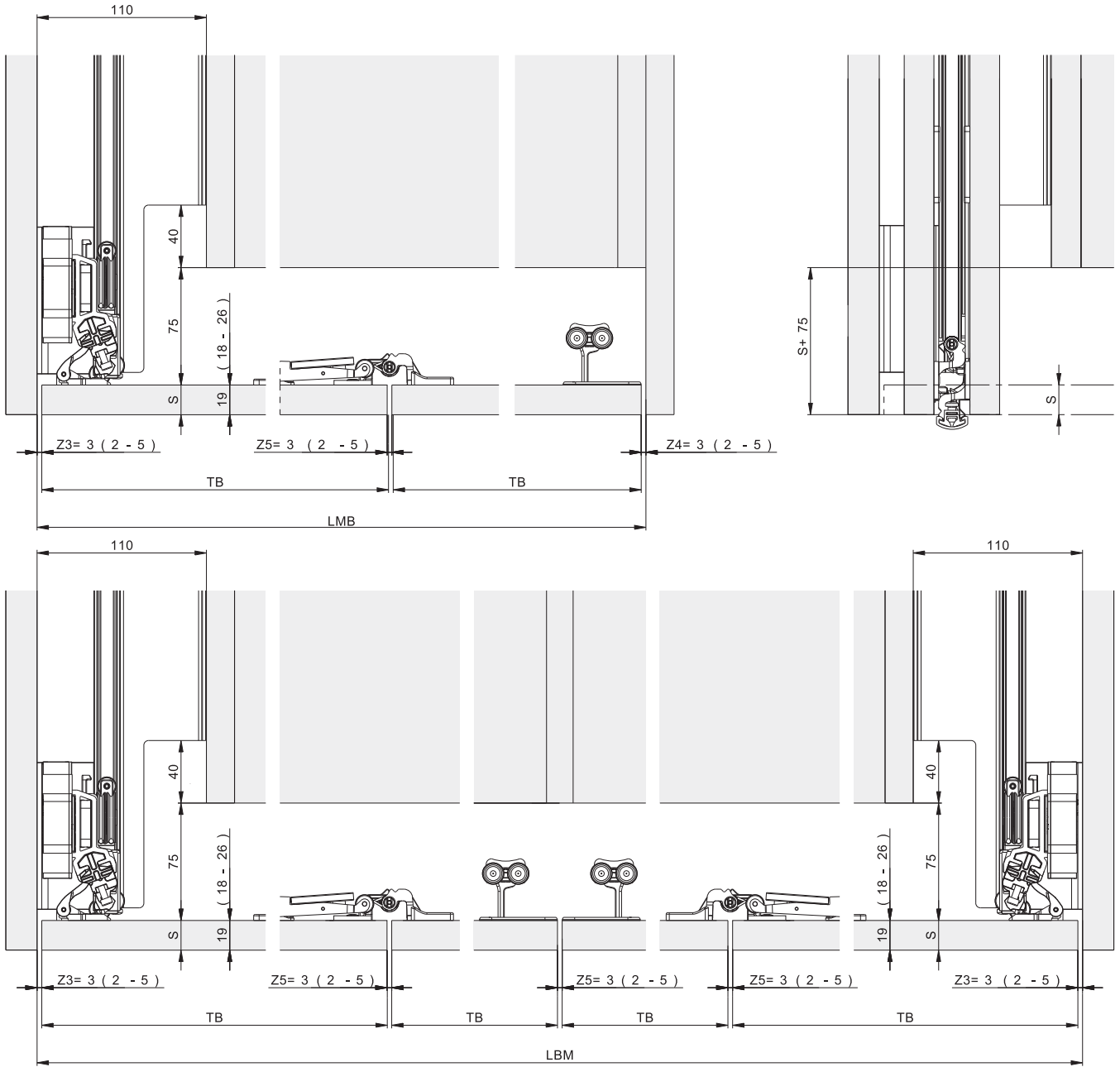

所需部件

两门系统

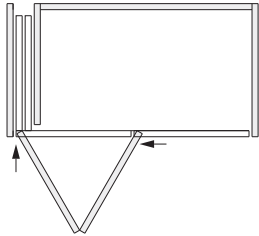

Hawa Folding Concepta III 20 Push, 左, 氧化铝

	编号
Hawa Folding Concepta III 20 Push, 基础套装配件, 高:1200-2200mm	31504
Hawa Folding Concepta III 20 Push, 推弹款滑轮组套装配件, 左	31508
Hawa Folding Concepta III 20/25, 导轨套装配件, 两门, 左, 氧化铝	31514
Hawa Folding Concepta III 20, 立柱, 高:1200-2200mm, 氧化铝	31519

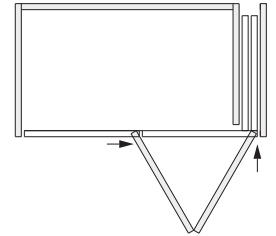

Hawa Folding Concepta III 20 Push, 右, 氧化铝

	编号
Hawa Folding Concepta III 20 Push, 基础套装配件, 高:1200-2200mm	31504
Hawa Folding Concepta III 20 Push, 推弹款滑轮组套装配件, 右	31509
Hawa Folding Concepta III 20/25, 导轨套装配件, 两门, 右, 氧化铝	31515
Hawa Folding Concepta III 20, 立柱, 高:1200-2200mm, 氧化铝	31519

氧化铝, 黑色

	编号
Hawa Folding Concepta III 20 Push, 基础套装配件, 高:1200-2200mm	31504
Hawa Folding Concepta III 20 Push, 推弹款滑轮组套装配件, 左	31508
Hawa Folding Concepta III 20/25, 导轨套装配件, 两门, 左, 氧化铝, 黑色	31521
Hawa Folding Concepta III 20, 立柱, 高:1200-2200mm, 氧化铝, 黑色	31526

氧化铝, 黑色

	编号
Hawa Folding Concepta III 20 Push, 基础套装配件, 高:1200-2200mm	31504
Hawa Folding Concepta III 20 Push, 推弹款滑轮组套装配件, 右	31509
Hawa Folding Concepta III 20/25, 导轨套装配件, 两门, 右, 氧化铝, 黑色	31522
Hawa Folding Concepta III 20, 立柱, 高:1200-2200mm, 氧化铝, 黑色	31526

四门系统

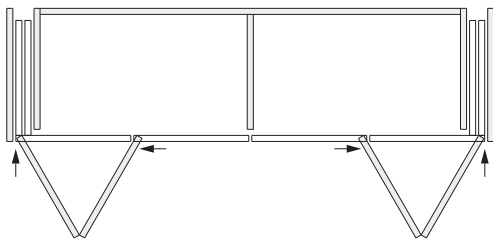

Hawa Folding Concepta III 20 Push, 左/右, 氧化铝

	数量	编号
Hawa Folding Concepta III 20 Push, 基础套装配件, 高:1200-2200mm	2	31504
Hawa Folding Concepta III 20 Push, 推弹款滑轮组套装配件, 左	1	31508
Hawa Folding Concepta III 20 Push, 推弹款滑轮组套装配件, 右	1	31509
Hawa Folding Concepta III 20/25, 导轨套装配件, 四门, 氧化铝	1	31518
Hawa Folding Concepta III 20, 立柱, 高:1200-2200mm, 氧化铝	2	31519

氧化铝, 黑色

	数量	编号
Hawa Folding Concepta III 20 Push, 基础套装配件, 高:1200-2200mm	2	31504
Hawa Folding Concepta III 20 Push, 推弹款滑轮组套装配件, 左	1	31508
Hawa Folding Concepta III 20 Push, 推弹款滑轮组套装配件, 右	1	31509
Hawa Folding Concepta III 20/25, 导轨套装配件, 四门, 氧化铝, 黑色	1	31525
Hawa Folding Concepta III 20, 立柱, 高:1200-2200mm, 氧化铝, 黑色	2	31526

三门系统

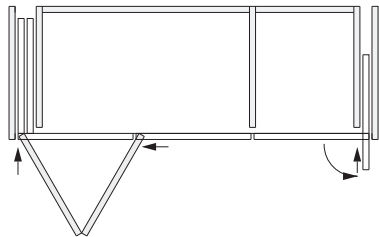

Hawa Folding Concepta III 20 Push, 左,
Hawa Concepta III 25 Push, 右, 氧化铝

	编号
Hawa Folding Concepta III 20 Push, 基础套装配件, 高:1200-2200mm	31504
Hawa Folding Concepta III 20 Push, 推弹款滑轮组套装配件, 左	31508
Hawa Folding Concepta III 20/25, 导轨套装配件, 三门, 左, 氧化铝	31516
Hawa Folding Concepta III 20, 立柱, 高:1200-2200mm, 氧化铝	31519
Hawa Concepta III 25 Push/Pull, 回旋推拉门基础套装配件, 右, 高:1200-2200mm	30995
Hawa Concepta III 25/35 Push, 回旋推拉门推弹套装配件, 右	30999
立柱, 适用门板高度1200-2200mm, 氧化铝	30778
55mm口袋连接器, 用于从外部连接柜体	31005

氧化铝, 黑色

	编号
Hawa Folding Concepta III 20 Push, 基础套装配件, 高:1200-2200mm	31504
Hawa Folding Concepta III 20 Push, 推弹款滑轮组套装配件, 左	31508
Hawa Folding Concepta III 20/25, 导轨套装配件, 三门, 左, 氧化铝, 黑色	31523
Hawa Folding Concepta III 20, 立柱, 高:1200-2200mm, 氧化铝, 黑色	31526
Hawa Concepta III 25 Push/Pull, 回旋推拉门基础套装配件, 右, 高:1200-2200mm	30995
Hawa Concepta III 25/35 Push, 回旋推拉门推弹套装配件, 右	30999
立柱, 适用门板高度1200-2200mm, 氧化铝	30778
55mm口袋连接器, 用于从外部连接柜体	31005

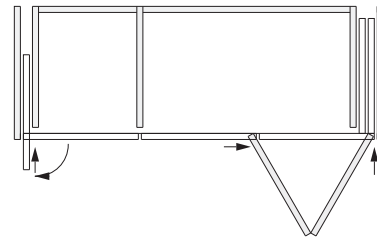

Hawa Folding Concepta III 20 Push, 右,
Hawa Concepta III 25 Push, 左, 氧化铝

	编号
Hawa Folding Concepta III 20 Push, 基础套装配件, 高:1200-2200mm	31504
Hawa Folding Concepta III 20 Push, 推弹款滑轮组套装配件, 右	31509
Hawa Folding Concepta III 20/25, 导轨套装配件, 三门, 右, 氧化铝	31517
Hawa Folding Concepta III 20, 立柱, 高:1200-2200mm, 氧化铝	31519
Hawa Concepta III 25 Push/Pull, 回旋推拉门基础套装配件, 左, 高:1200-2200mm	30994
Hawa Concepta III 25/35 Push, 回旋推拉门推弹套装配件, 左	30998
立柱, 适用门板高度1200-2200mm, 氧化铝	30778
55mm口袋连接器, 用于从外部连接柜体	31005

氧化铝, 黑色

	编号
Hawa Folding Concepta III 20 Push, 基础套装配件, 高:1200-2200mm	31504
Hawa Folding Concepta III 20 Push, 推弹款滑轮组套装配件, 右	31509
Hawa Folding Concepta III 20/25, 导轨套装配件, 三门, 右, 氧化铝, 黑色	31524
Hawa Folding Concepta III 20, 立柱, 高:1200-2200mm, 氧化铝, 黑色	31526
Hawa Concepta III 25 Push/Pull, 回旋推拉门基础套装配件, 左, 高:1200-2200mm	30994
Hawa Concepta III 25/35 Push, 回旋推拉门推弹套装配件, 左	30998
立柱, 适用门板高度1200-2200mm, 氧化铝	30778
55mm口袋连接器, 用于从外部连接柜体	31005

Hawa 配置器

www.hawa.com/configurator →

套装包含的单独部件列表

20kg折叠回旋转移门基础套装配件

		编号	
Hawa Folding Concepta III 20 Push, 基础套装配件, 高:1200-2200mm		31504	
		31504	编号
全套配件包括:			
	隐藏式铰链固定件, 塑料, 黑色	3	30686
	铰链限位器, 高度可调, 镀镍钢	1	30738
	隐藏式铰链, 不带关门阻尼和自闭弹簧, 镀镍钢	3	31435
	带弹簧的隐藏式中心铰链, 钢, 镀镍哑光	3	30794
	隐藏式铰链和隐藏式中心铰链专用螺丝, 4×16mm, 20个/套	1	31532
	折叠门承重轮, 镀镍	1	31313
	折叠门承重轮铰链	1	31314
	折叠门推弹器和关门阻尼专用螺丝套装	1	31531
	折叠门关门阻尼	1	31064
	折叠门推弹器	1	31332
	折叠门推弹器, 塑料, 黑色	1	31036
	调节工具套装	1	31047
	沉头螺丝, 4.5×16mm, 镀锌钢, 28件/套	1	31529
	顶部导轨和底部口袋连接器螺丝	1	31530

推弹款滑轮组套装配件

		编号		
Hawa Folding Concepta III 20 Push, 推弹款滑轮组套装配件, 左		31508		
Hawa Folding Concepta III 20 Push, 推弹款滑轮组套装配件, 右		31509		
		31508	31509	编号
全套配件包括:				
	Hawa Folding Concepta III 20 Push 推弹组件, 左	1		31448
	推弹装置末端限位支架, 镀锌钢	1	1	31072
	推弹装置, 塑料, 黑色	1	1	31010
	滑轮装置固定器, 塑料, 黑色	1	1	30966
	折叠门推弹器粘接板, 带双面胶带, 银灰色和黑色	1	1	52118
	Hawa Folding Concepta III 20 Push 推弹组件, 右		1	31450

导轨套装配件, 适用于两门/四门, 氧化铝

	编号
Hawa Folding Concepta III 20/25, 导轨套装配件, 两门, 左, 氧化铝	31514
Hawa Folding Concepta III 20/25, 导轨套装配件, 两门, 右, 氧化铝	31515
Hawa Folding Concepta III 20/25, 导轨套装配件, 四门, 氧化铝	31518

全套配件包括:

	31514	31515	31518	编号
 顶部导轨, 左上角, 氧化铝, 长820mm	1		1	31339
 前导轨, 氧化铝, 长1272mm	1	1		31210
 弧形导轨, 左, 氧化铝	1		1	31365
 底部导轨, 左, 820mm, 氧化铝	1		1	31336
 口袋连接器, 左上角, 长788mm	1		1	31370
 顶部口袋连接器咬合杆, 铝, 长660mm	1	1	2	30977
 底部导轨连接件, 塑料, 黑色, 长94mm	3	3	6	31086
 弧形导轨连接件, 镀锌钢	1	1	2	31543
 顶部导轨支撑件, 塑料, 黑色	1	1	2	31359
 顶部承重轨道适配器, 塑料, 炭黑色, 4件/套	1	1	2	23645
 顶部承重轨道适配器沉头螺丝, 4.5x16mm, 16件/套	1	1	2	31585



续表见下一栏

接上一栏

 顶部导轨, 右上角, 氧化铝, 长820mm	1	1		31340
 弧形导轨, 右, 氧化铝	1	1		31366
 底部导轨, 右, 820mm, 氧化铝	1	1		31337
 口袋连接器, 右上角, 长788mm	1	1		31371
 前导轨, 氧化铝, 长1272mm			1	31343

立柱套装配件, 氧化铝

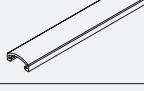
	编号
Hawa Folding Concepta III 20, 立柱, 高:1200-2200mm, 氧化铝	31519

	31519	编号
全套配件包括:		
 立柱, 适用门板高度1200-2200mm, 氧化铝	1	30778
 门缝装饰盖板, 适用门板高度1200-2200mm, 氧化铝, 长2200mm	1	31230
 盖板固定夹, 2200mm, 塑料, 黑色, 8件/套	1	31502

导轨套装配件, 适用于三门系统, 氧化铝

	编号
Hawa Folding Concepta III 20/25, 导轨套装配件, 三门, 左, 氧化铝	31516
Hawa Folding Concepta III 20/25, 导轨套装配件, 三门, 右, 氧化铝	31517

全套配件包括:

	31516	31517	编号
 顶部导轨, 左上角, 氧化铝, 长820mm	1		31339
 前导轨, 氧化铝, 长1954mm	1	1	31341
 弧形导轨, 左, 氧化铝	1		31365
 底部导轨, 左, 820mm, 氧化铝	1		31336
 口袋连接器, 左上角, 长788mm	1		31370
 顶部口袋连接器咬合杆, 铝, 长660mm	1	1	30977
 底部导轨连接件, 塑料, 黑色, 长94mm	3	3	31086
 弧形导轨连接件, 镀锌钢	1	1	31543
 顶部导轨支撑件, 塑料, 黑色	1	1	31359
 顶部承重轨道适配器, 塑料, 炭黑色, 6件/套	1	1	24870
 三门系统专用门板止位器, 适用推拉款和推弹款	1	1	31538
 顶部承重轨道适配器沉头螺丝, 4.5×16mm, 16件/套	1	1	31587

接上一栏

 顶部导轨, 右上角, 氧化铝, 长820mm	1	31340
 弧形导轨, 右, 氧化铝	1	31366
 底部导轨, 右, 820mm, 氧化铝	1	31337
 口袋连接器, 右上角, 长788mm	1	31371

续表见下一栏

导轨套装配件, 适用两门/四门, 氧化铝, 黑色

	编号
Hawa Folding Concepta III 20/25, 导轨套装配件, 两门, 左, 氧化铝, 黑色	31521
Hawa Folding Concepta III 20/25, 导轨套装配件, 两门, 右, 氧化铝, 黑色	31522
Hawa Folding Concepta III 20/25, 导轨套装配件, 四门, 氧化铝, 黑色	31525



全套配件包括:		31521	31522	31525	编号
	顶部导轨, 左上角, 氧化铝, 长820mm	1	1		31339
	前导轨, 氧化铝, 长1272mm	1	1		31211
	弧形导轨, 左, 氧化铝, 黑色	1		1	31367
	底部导轨, 左, 820mm, 氧化铝	1		1	31336
	口袋连接器, 左上角, 长788mm	1		1	31370
	顶部口袋连接器咬合杆, 铝, 长660mm	1	1	2	30977
	底部导轨连接件, 塑料, 黑色, 长94mm	3	3	6	31086
	弧形导轨连接件, 镀锌钢	1	1	2	31543
	顶部导轨支撑件, 塑料, 黑色	1	1	2	31359
	顶部承重轨道适配器, 塑料, 炭黑色, 4件/套	1	1	2	23645
	顶部承重轨道适配器沉头螺丝, 4.5x16mm, 16件/套	1	1	2	31585

接上一栏

	修补笔, 黑色	1	1	1	52117
	顶部导轨, 右上角, 氧化铝, 长820mm		1	1	31340
	弧形导轨, 右, 氧化铝, 黑色		1	1	31368
	底部导轨, 右, 820mm, 氧化铝		1	1	31337
	口袋连接器, 右上角, 长788mm		1	1	31371
	前导轨, 氧化铝, 黑色, 长2539mm			1	31344

立柱套装配件, 氧化铝, 黑色

	编号
Hawa Folding Concepta III 20, 立柱, 高:1200-2200mm, 氧化铝, 黑色	31526

全套配件包括:		31526	编号
	立柱, 适用门板高度1200-2200mm, 氧化铝	1	30778
	门缝装饰盖板, 适用门板高度1200-2200mm, 氧化铝, 黑色, 长2200mm		31231
	盖板固定夹, 2200mm, 塑料, 黑色, 8件/套		31502

续表见下一栏

导轨套装配件, 适用于三门系统, 氧化铝, 黑色

	编号
Hawa Folding Concepta III 20/25, 导轨套装配件, 三门, 左, 氧化铝, 黑色	31523
Hawa Folding Concepta III 20/25, 导轨套装配件, 三门, 右, 氧化铝, 黑色	31524

全套配件包括:

	31523	31524	编号
 顶部导轨, 左上角, 氧化铝, 长820mm	1		31339
 前导轨, 氧化铝, 黑色, 长1954mm	1	1	31342
 弧形导轨, 左, 氧化铝, 黑色	1		31367
 底部导轨, 左, 820mm, 氧化铝	1		31336
 口袋连接器, 左上角, 长788mm	1		31370
 顶部口袋连接器咬合杆, 铝, 长660mm	1	1	30977
 底部导轨连接件, 塑料, 黑色, 长94mm	3	3	31086
 弧形导轨连接件, 镀锌钢	1	1	31543
 顶部导轨支撑件, 塑料, 黑色	1	1	31359
 顶部承重轨道适配器, 塑料, 炭黑色, 6件/套	1	1	24870
 三门系统专用门板止位器, 适用推拉款和推弹款	1	1	31538
 顶部承重轨道适配器沉头螺丝, 4.5x16mm, 16件/套	1	1	31587

接上一栏

	修补笔, 黑色	1	1	52117
	顶部导轨, 右上角, 氧化铝, 长820mm		1	31340
	弧形导轨, 右, 氧化铝, 黑色		1	31368
	底部导轨, 右, 820mm, 氧化铝		1	31337
	口袋连接器, 右上角, 长788mm		1	31371

续表见下一栏



加固配件

		编号
	加固配件, 2765mm, 适用四门, 氧化铝	52109
	加固配件, 2085mm, 适用三门, 氧化铝	52110

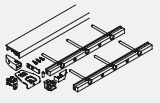
底座配件

		编号
	底座配件套装, 两门, 氧化铝	52089
	底座配件套装, 三门, 氧化铝	52090
	底座配件套装, 四门, 氧化铝	52091
	底座配件套装, 两门, 氧化铝, 黑色	52092
	底座配件套装, 三门, 氧化铝, 黑色	52093
	底座配件套装, 四门, 氧化铝, 黑色	52094

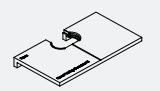
选装配件

		编号
	折叠门铰链开孔模具	52121
	门板找平装置(带磁性), 带钻孔模板, 氧化铝	24006

门板拉直器

→ 在第323页的附件中查找详细信息
铝, 未经处理

		编号
	门板拉直器, 1715-2275mm, 铝	056.3192.079
	门板拉直器, 1215-1775mm, 铝	056.3192.073

氧化铝

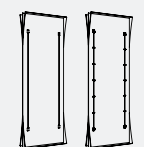
		编号
	门板拉直器, 1775-2275mm, 氧化铝, 可调节尺寸, 适用于1215-1712mm的门板	056.3192.080

氧化铝, 黑色

		编号
	门板拉直器, 1715-2275mm, 氧化铝, 黑色	056.3192.081
	门板拉直器, 1215-1775mm, 氧化铝, 黑色	056.3192.076

门板拉直器

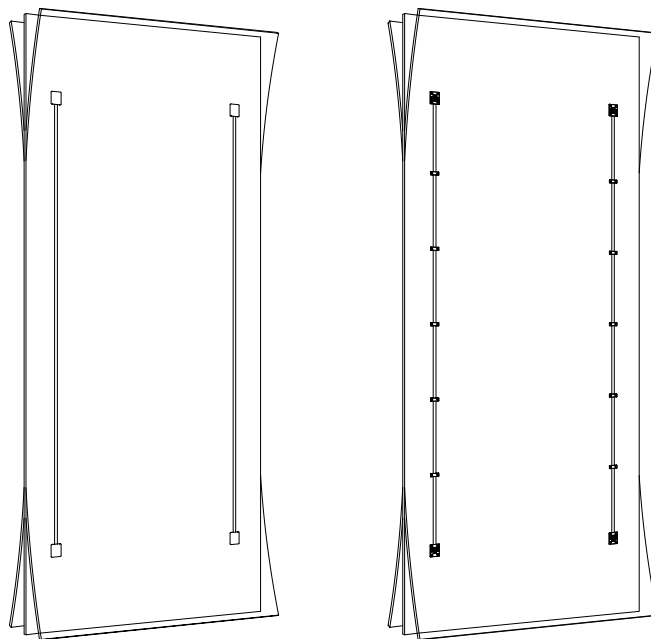

更多安装示例
两门/四门系统外盖门,带底座型材

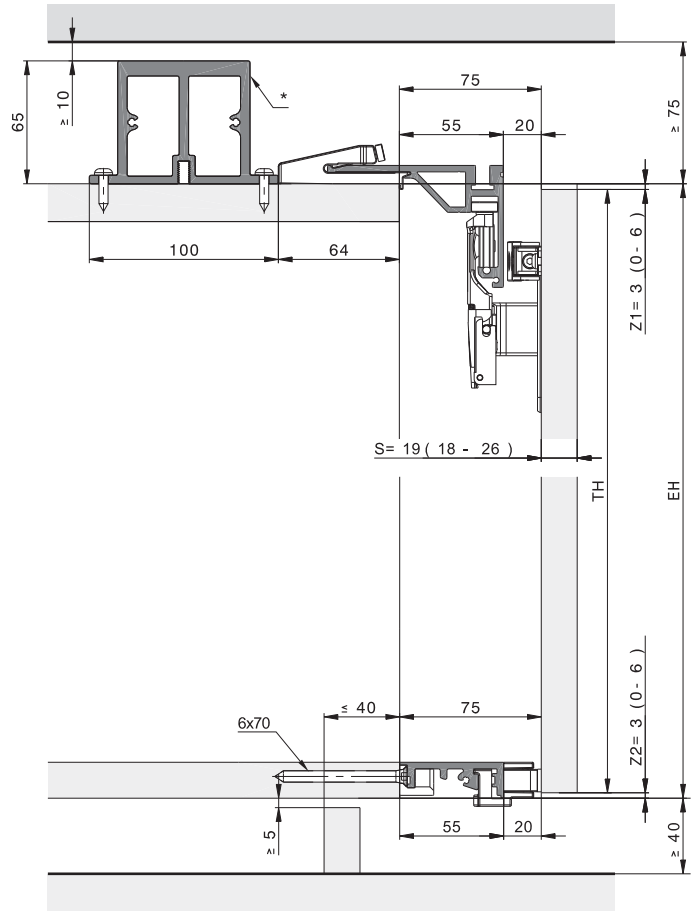
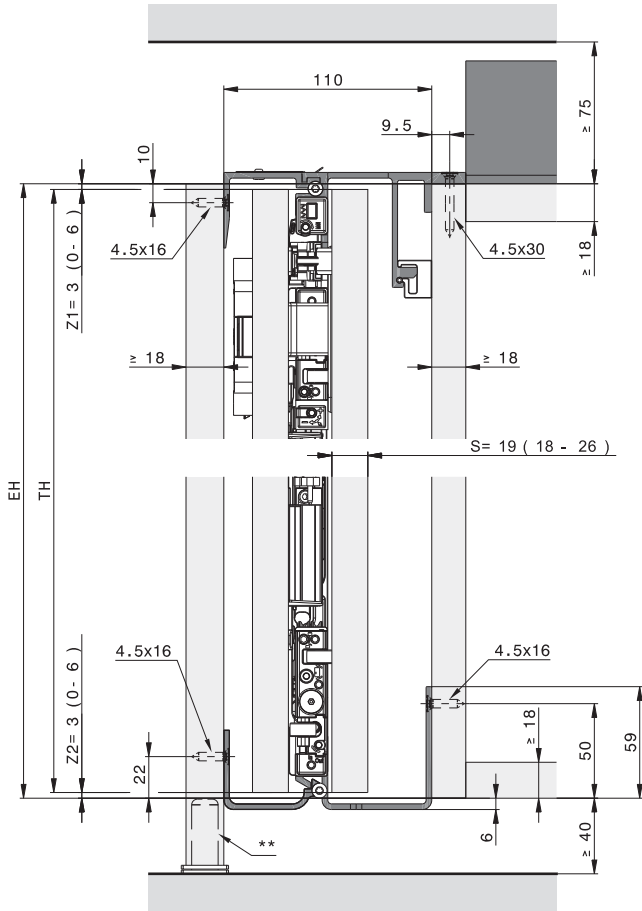

- * 加固配件适用于无中竖板的三门和四门系统
- ** 建议:使用调节脚

一门到顶无底板
两门/四门系统

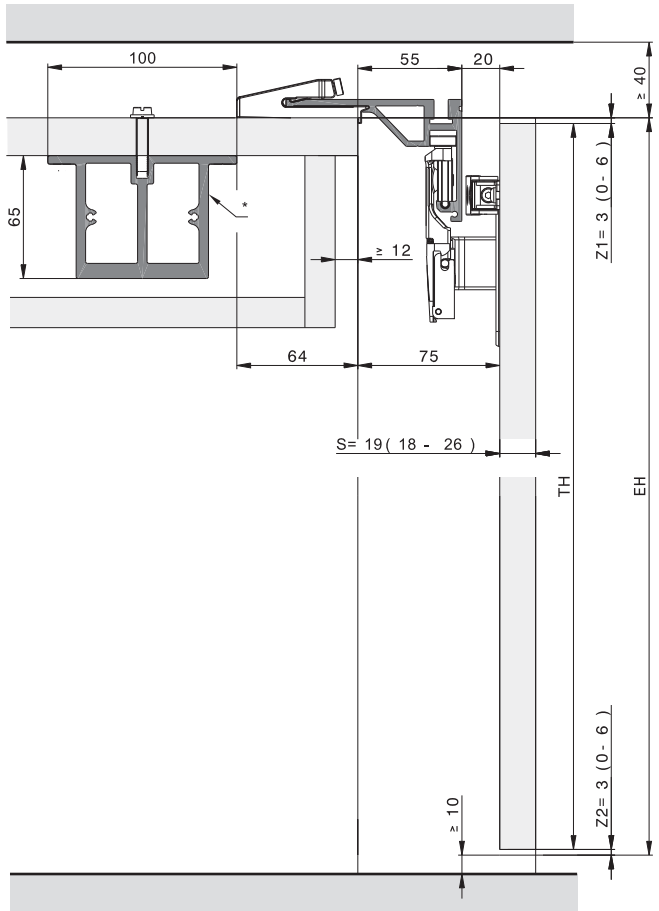
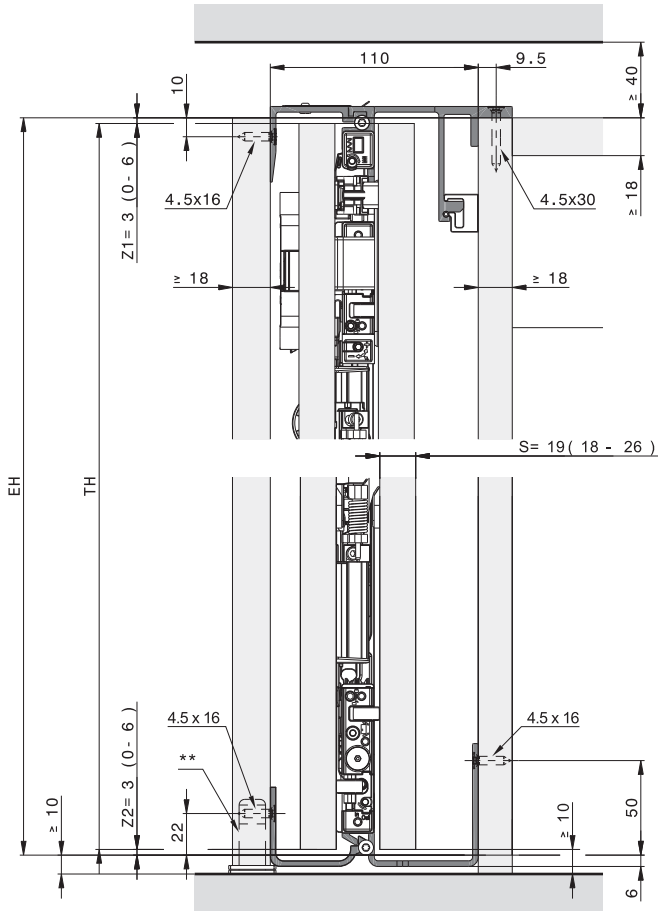

- * 加固配件适用于无中竖板的三门和四门系统
- ** 建议:使用调节脚

三门系统外盖门, 无底座型材

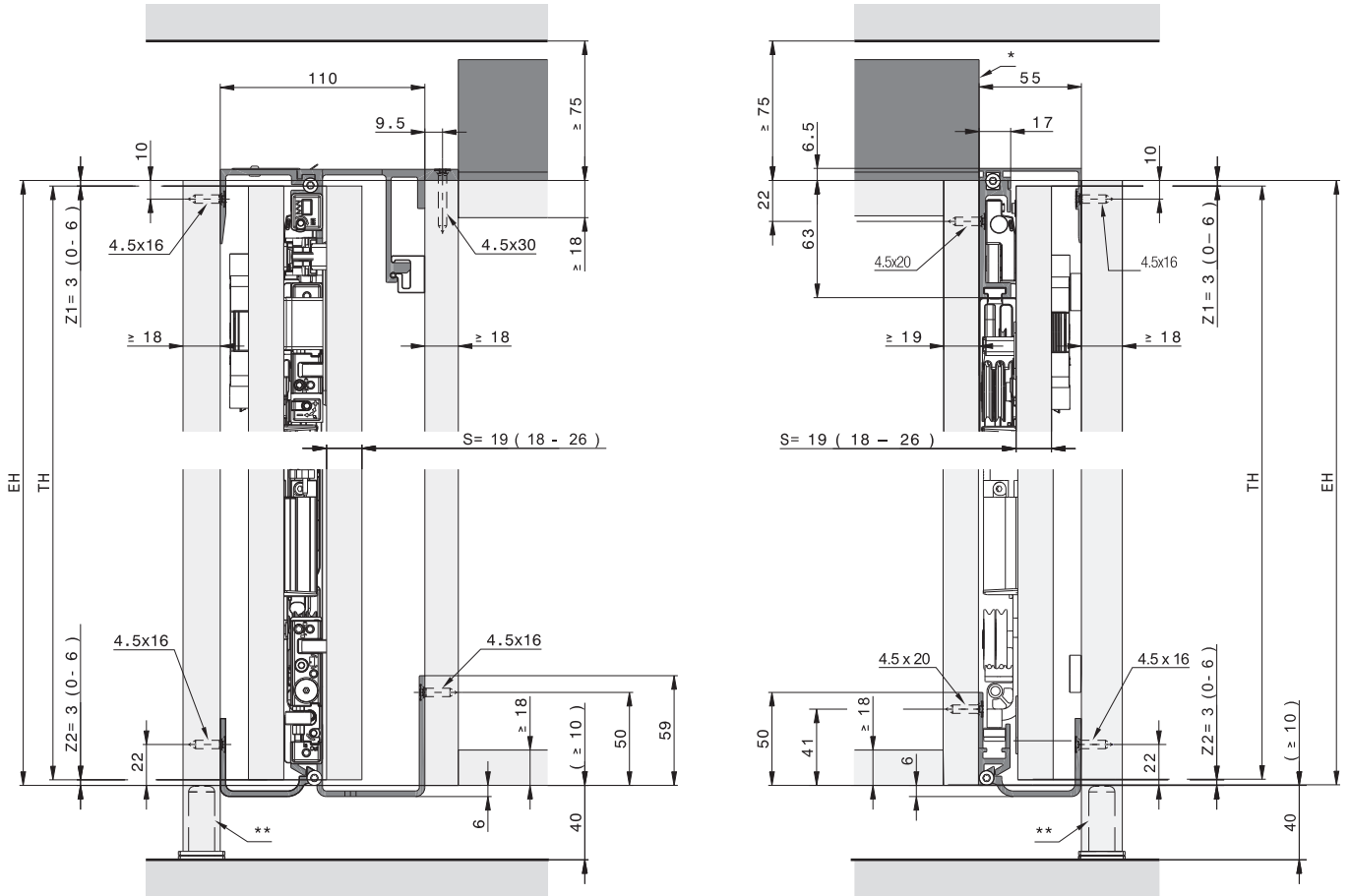

- * 加固配件适用于无中竖板的三门和四门系统
- ** 建议: 使用调节脚

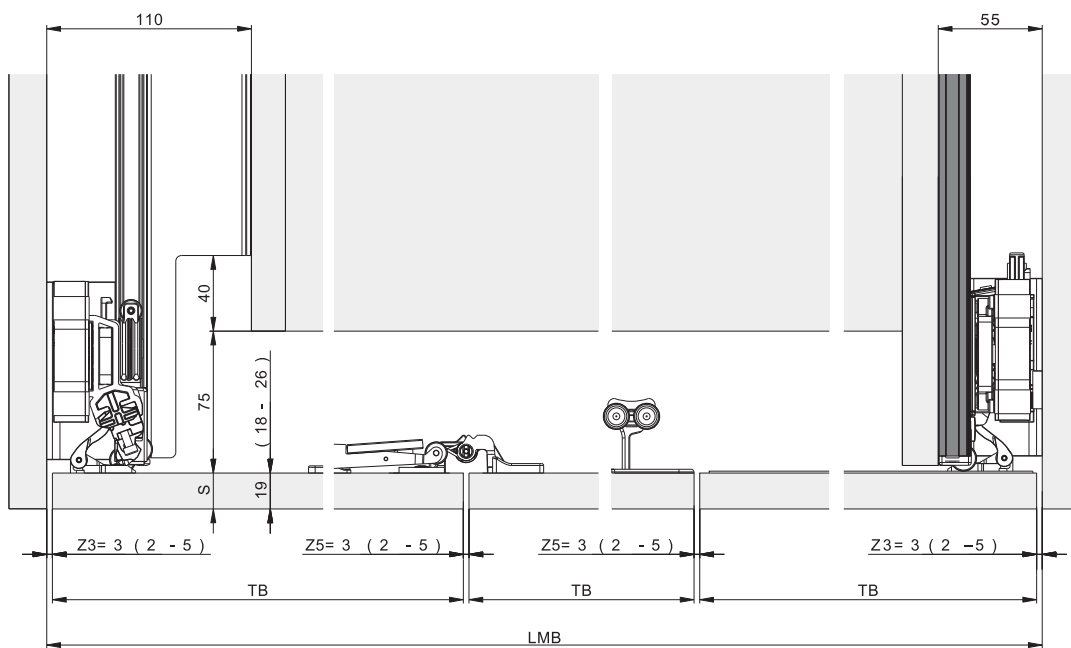

安装深度计算
门板平外侧板

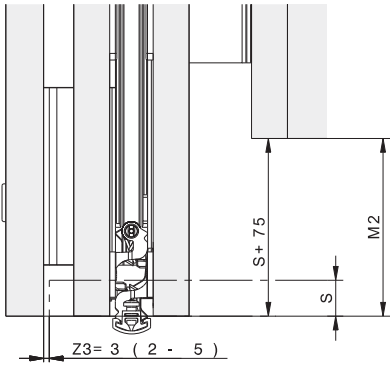

门板凸出外侧板

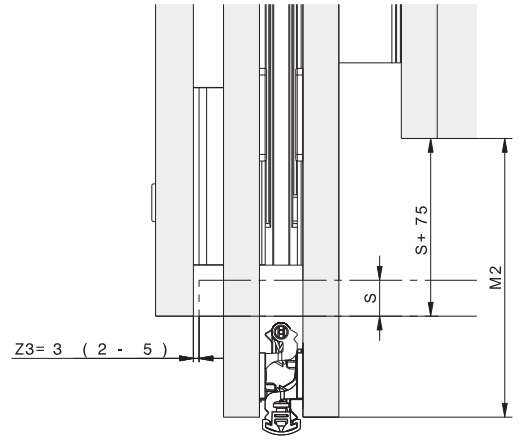

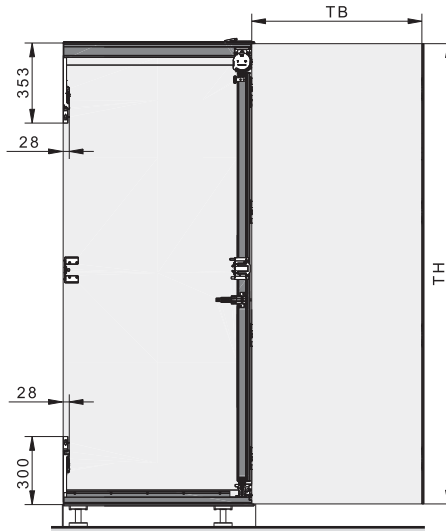
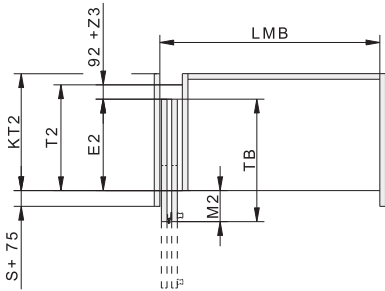

	mm
T2	$TB + 92 + Z3 - M2$
E2	$TB - M2$
KT2	$\geq T2$
M2	$\geq S + 75$ $\leq TB - 390$







- S = 门板厚度
- Z = 门缝
- E2 = 可推入深度
- T2 = 配件深度
- TB = 门板宽度
- TH = 门板高度
- KT2 = 柜体深度
- LMB = 柜体净宽
- M2 = 门板凸出柜体距离

适用于20kg旋转推入式折叠木门的五金件。统一,齐平的门板设计搭配均匀的门缝。
隐形设计,带拉手版本。

产品亮点

-  **灵活** 多种门板尺寸,适用于落地式、步入式衣柜,可搭配Hawa Concepta III
-  **高效** 得益于高度的预组装和简单的调节,安装更便捷
-  **舒适** 单手可以轻松打开和关闭

技术标准

-  门板重量 6-20kg
-  门板高度 1200-2200mm
-  门板宽度 440-750mm
-  门板厚度 18-26mm

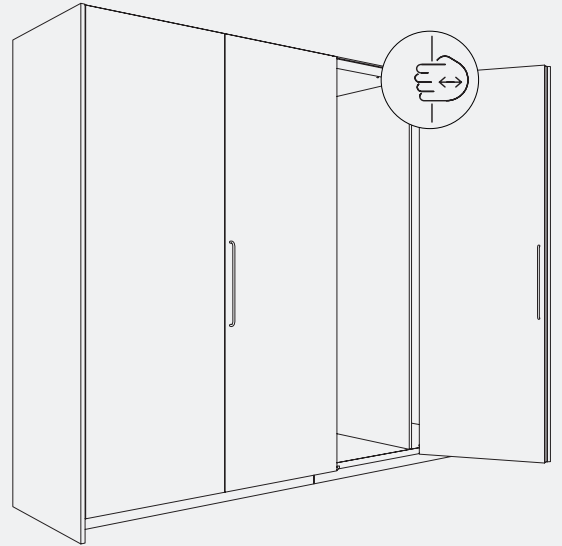

安装示例
外盖门,无底座型材

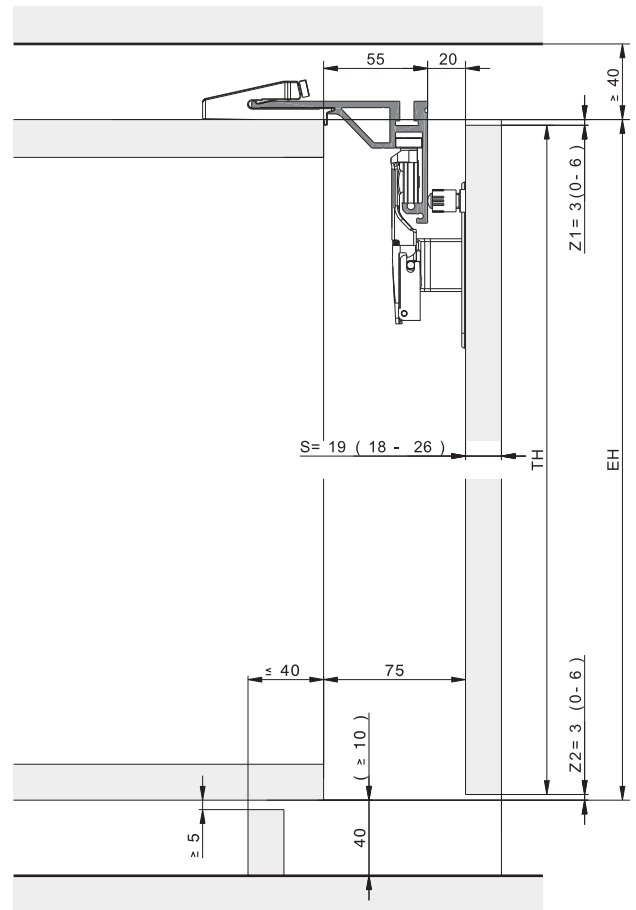
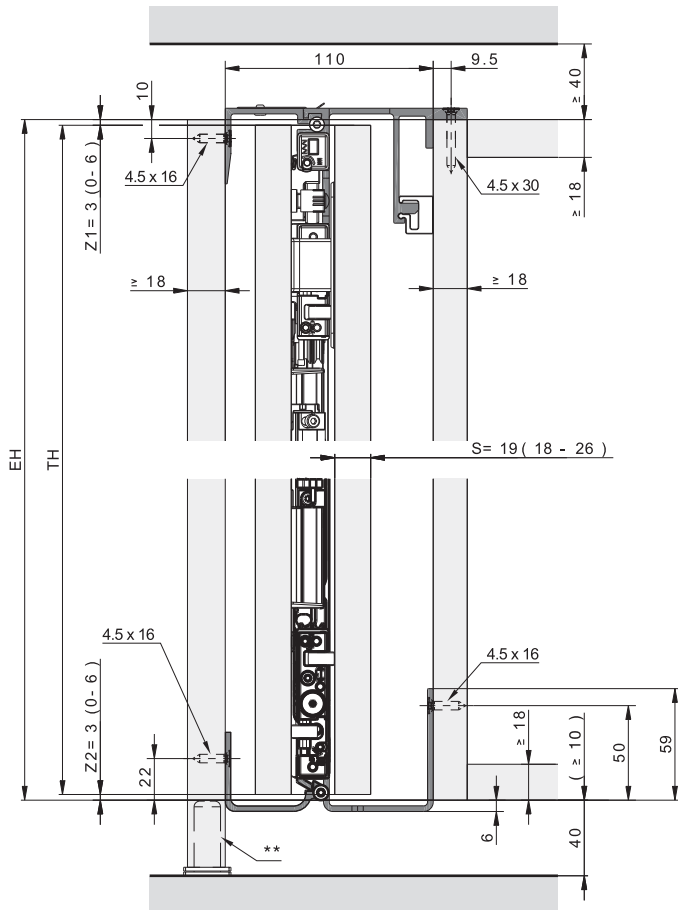

** 建议:使用调节脚

两门/四门系统外盖门, 无底座型材

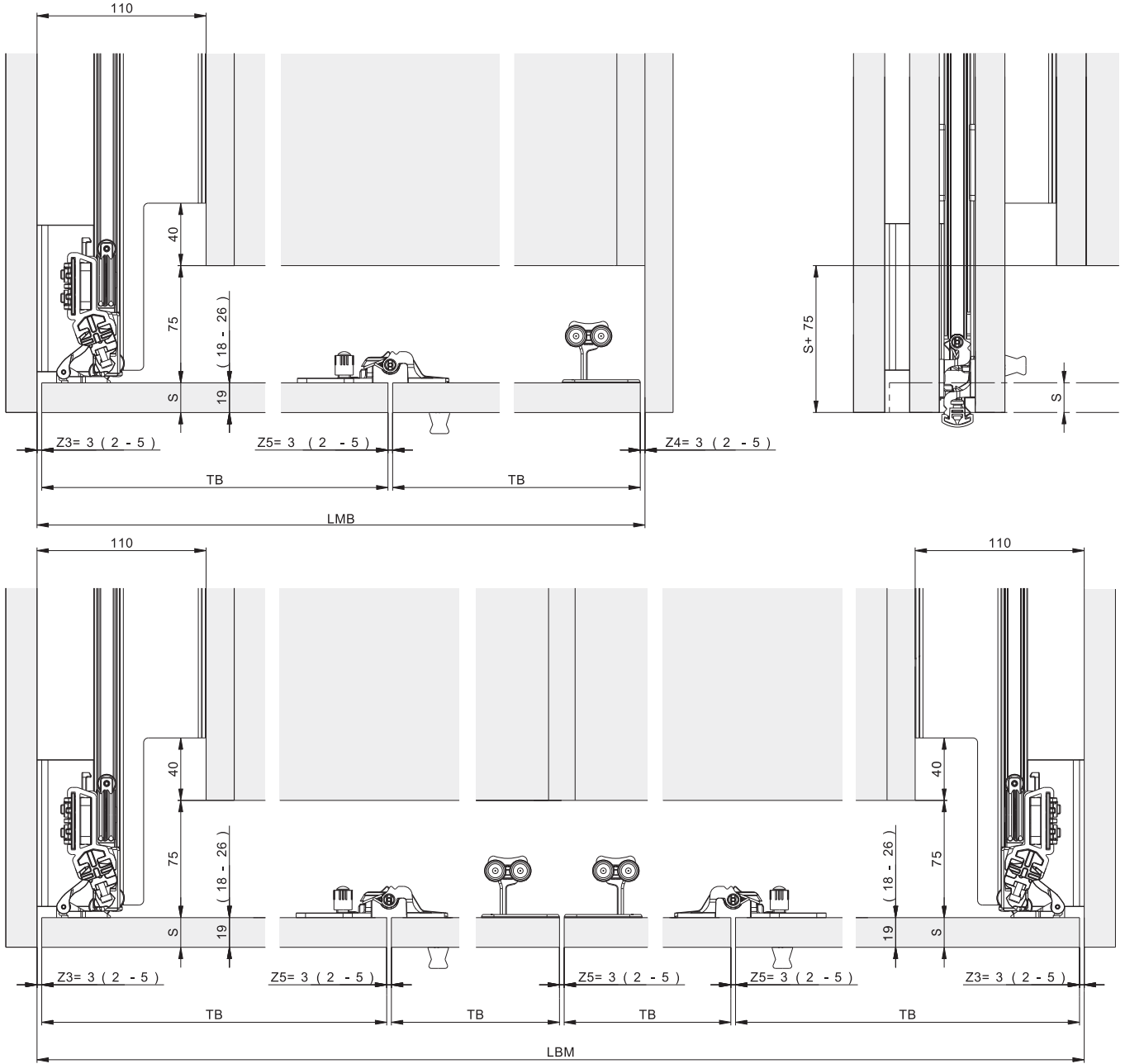

所需部件

两门系统

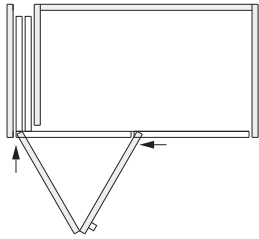

Hawa Folding Concepta III 20 Pull, 左, 氧化铝

	编号
Hawa Folding Concepta III 20 Pull, 基础套装配件, 高:1200-2200mm	31506
Hawa Folding Concepta III 20/25 Pull, 推拉款滑轮组套装配件, 左	31512
Hawa Folding Concepta III 20/25, 导轨套装配件, 两门, 左, 氧化铝	31514
Hawa Folding Concepta III 20, 立柱, 高:1200-2200mm, 氧化铝	31519

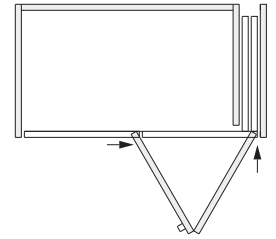

Hawa Folding Concepta III 20 Pull, 右, 氧化铝

	编号
Hawa Folding Concepta III 20 Pull, 基础套装配件, 高:1200-2200mm	31506
Hawa Folding Concepta III 20/25 Pull, 推拉款滑轮组套装配件, 右	31513
Hawa Folding Concepta III 20/25, 导轨套装配件, 两门, 右, 氧化铝	31515
Hawa Folding Concepta III 20, 立柱, 高:1200-2200mm, 氧化铝	31519

氧化铝, 黑色

	编号
Hawa Folding Concepta III 20 Pull, 基础套装配件, 高:1200-2200mm	31506
Hawa Folding Concepta III 20/25 Pull, 推拉款滑轮组套装配件, 左	31512
Hawa Folding Concepta III 20/25, 导轨套装配件, 两门, 左, 氧化铝, 黑色	31521
Hawa Folding Concepta III 20, 立柱, 高:1200-2200mm, 氧化铝, 黑色	31526

氧化铝, 黑色

	编号
Hawa Folding Concepta III 20 Pull, 基础套装配件, 高:1200-2200mm	31506
Hawa Folding Concepta III 20/25 Pull, 推拉款滑轮组套装配件, 右	31513
Hawa Folding Concepta III 20/25, 导轨套装配件, 两门, 右, 氧化铝, 黑色	31522
Hawa Folding Concepta III 20, 立柱, 高:1200-2200mm, 氧化铝, 黑色	31526

四门系统

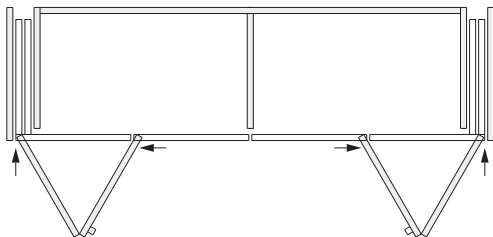

Hawa Folding Concepta III 20 Pull, 左/右, 氧化铝

	数量	编号
Hawa Folding Concepta III 20 Pull, 基础套装配件, 高:1200-2200mm	2	31506
Hawa Folding Concepta III 20/25 Pull, 推拉款滑轮组套装配件, 左	1	31512
Hawa Folding Concepta III 20/25 Pull, 推拉款滑轮组套装配件, 右	1	31513
Hawa Folding Concepta III 20/25, 导轨套装配件, 四门, 氧化铝	1	31518
Hawa Folding Concepta III 20, 立柱, 高:1200-2200mm, 氧化铝	2	31519

氧化铝, 黑色

	数量	编号
Hawa Folding Concepta III 20 Pull, 基础套装配件, 高:1200-2200mm	2	31506
Hawa Folding Concepta III 20/25 Pull, 推拉款滑轮组套装配件, 左	1	31512
Hawa Folding Concepta III 20/25 Pull, 推拉款滑轮组套装配件, 右	1	31513
Hawa Folding Concepta III 20/25, 导轨套装配件, 四门, 氧化铝, 黑色	1	31525
Hawa Folding Concepta III 20, 立柱, 高:1200-2200mm, 氧化铝, 黑色	2	31526

三门系统

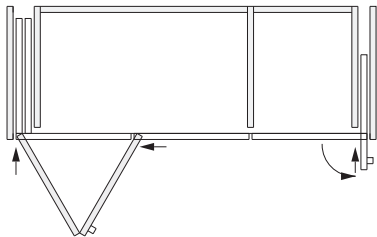

Hawa Folding Concepta III 20 Pull, 左,
Hawa Concepta III 25 Pull, 右, 氧化铝

	编号
Hawa Folding Concepta III 20 Pull, 基础套装配件, 高:1200-2200mm	31506
Hawa Folding Concepta III 20/25 Pull, 推拉款滑轮组套装配件, 左	31512
Hawa Folding Concepta III 20/25, 导轨套装配件, 三门, 左, 氧化铝	31516
Hawa Folding Concepta III 20, 立柱, 高:1200-2200mm, 氧化铝	31519
Hawa Concepta III 25 Push/Pull, 回旋推拉门基础套装配件, 右, 高:1200-2200mm	30995
Hawa Concepta III 25/35 Pull, 回旋推拉门推拉套装配件, 右	31001
立柱, 适用门板高度1200-2200mm, 氧化铝	30778
55mm口袋连接器, 用于从外部连接柜体	31005

氧化铝, 黑色

	编号
Hawa Folding Concepta III 20 Pull, 基础套装配件, 高:1200-2200mm	31506
Hawa Folding Concepta III 20/25 Pull, 推拉款滑轮组套装配件, 左	31512
Hawa Folding Concepta III 20/25, 导轨套装配件, 三门, 左, 氧化铝, 黑色	31523
Hawa Folding Concepta III 20, 立柱, 高:1200-2200mm, 氧化铝, 黑色	31526
Hawa Concepta III 25 Push/Pull, 回旋推拉门基础套装配件, 右, 高:1200-2200mm	30995
Hawa Concepta III 25/35 Pull, 回旋推拉门推拉套装配件, 右	31001
立柱, 适用门板高度1200-2200mm, 氧化铝	30778
55mm口袋连接器, 用于从外部连接柜体	31005

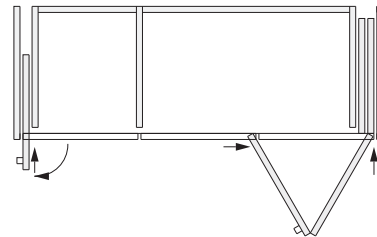

Hawa Folding Concepta III 20 Pull, 右,
Hawa Concepta III 25 Pull, 左, 氧化铝

	编号
Hawa Folding Concepta III 20 Pull, 基础套装配件, 高:1200-2200mm	31506
Hawa Folding Concepta III 20/25 Pull, 推拉款滑轮组套装配件, 右	31513
Hawa Folding Concepta III 20/25, 导轨套装配件, 三门, 右, 氧化铝	31517
Hawa Folding Concepta III 20, 立柱, 高:1200-2200mm, 氧化铝	31519
Hawa Concepta III 25 Push/Pull, 回旋推拉门基础套装配件, 左, 高:1200-2200mm	30994
Hawa Concepta III 25/35 Pull, 回旋推拉门推拉套装配件, 左	31000
立柱, 适用门板高度1200-2200mm, 氧化铝	30778
55mm口袋连接器, 用于从外部连接柜体	31005

氧化铝, 黑色

	编号
Hawa Folding Concepta III 20 Pull, 基础套装配件, 高:1200-2200mm	31506
Hawa Folding Concepta III 20/25 Pull, 推拉款滑轮组套装配件, 右	31513
Hawa Folding Concepta III 20/25, 导轨套装配件, 三门, 右, 氧化铝, 黑色	31524
Hawa Folding Concepta III 20, 立柱, 高:1200-2200mm, 氧化铝, 黑色	31526
Hawa Concepta III 25 Push/Pull, 回旋推拉门基础套装配件, 左, 高:1200-2200mm	30994
Hawa Concepta III 25/35 Pull, 回旋推拉门推拉套装配件, 左	31000
立柱, 适用门板高度1200-2200mm, 氧化铝	30778
55mm口袋连接器, 用于从外部连接柜体	31005

Hawa 配置器

www.hawa.com/configurator →

套装包含的单独部件列表

20kg折叠回旋转移门基础套装配件

		编号	
Hawa Folding Concepta III 20 Pull, 基础套装配件, 高:1200-2200mm		31506	
		31506	编号
全套配件包括:			
	隐藏式铰链固定件, 塑料, 黑色	3	30686
	铰链限位器, 高度可调, 镀镍钢	1	30738
	隐藏式铰链, 带关门阻尼和自 闭弹簧, 镀镍钢	3	31070
	带弹簧的隐藏式中心铰链, 钢, 镀镍哑光	3	31362
	隐藏式铰链和隐藏式中心铰链 专用螺丝, 4×16mm, 20个/套	1	31532
	折叠门承重轮, 镀镍	1	31313
	折叠门承重轮铰链	1	31314
	阻尼闭门系统, 带终端限位器	1	31222
	可调节缓冲器, 塑料, 炭黑色	1	31550
	调节工具套装	1	31047
	沉头螺丝, 4.5×16mm, 镀锌 钢, 28件/套	1	31529
	顶部导轨和底部口袋连接器 螺丝	1	31530

推拉款滑轮组套装配件

		编号		
Hawa Folding Concepta III 20/25 Pull, 推拉款滑轮组套装配件, 左		31512		
Hawa Folding Concepta III 20/25 Pull, 推拉款滑轮组套装配件, 右		31513		
		31512	31513	
全套配件包括:				
	Folding Concepta III 20/25 Pull, 滑轮装置, 左	1	31004	
	推弹装置末端限位支架, 镀锌钢	1	1	31541
	滑轮装置固定器, 塑料, 黑色	1	1	30966
	Folding Concepta III 20/25 Pull, 滑轮装置, 右		1	31046

导轨套装配件, 适用于两门/四门, 氧化铝

	编号
Hawa Folding Concepta III 20/25, 导轨套装配件, 两门, 左, 氧化铝	31514
Hawa Folding Concepta III 20/25, 导轨套装配件, 两门, 右, 氧化铝	31515
Hawa Folding Concepta III 20/25, 导轨套装配件, 四门, 氧化铝	31518

全套配件包括:

	31514	31515	31518	编号
 顶部导轨, 左上角, 氧化铝, 长820mm	1	1		31339
 前导轨, 氧化铝, 长1272mm	1	1		31210
 弧形导轨, 左, 氧化铝	1		1	31365
 底部导轨, 左, 820mm, 氧化铝	1		1	31336
 口袋连接器, 左上角, 长788mm	1		1	31370
 顶部口袋连接器咬合杆, 铝, 长660mm	1	1	2	30977
 底部导轨连接件, 塑料, 黑色, 长94mm	3	3	6	31086
 弧形导轨连接件, 镀锌钢	1	1	2	31543
 顶部导轨支撑件, 塑料, 黑色	1	1	2	31359
 顶部承重轨道适配器, 塑料, 炭黑色, 4件/套	1	1	2	23645
 顶部承重轨道适配器沉头螺丝, 4.5x16mm, 16件/套	1	1	2	31585



续表见下一栏

接上一栏

 顶部导轨, 右上角, 氧化铝, 长820mm	1	1		31340
 弧形导轨, 右, 氧化铝	1	1		31366
 底部导轨, 右, 820mm, 氧化铝	1	1		31337
 口袋连接器, 右上角, 长788mm	1	1		31371
 前导轨, 氧化铝, 长1272mm			1	31343

立柱套装配件, 氧化铝

	编号
Hawa Folding Concepta III 20, 立柱, 高:1200-2200mm, 氧化铝	31519

	31519	编号
 立柱, 适用门板高度1200-2200mm, 氧化铝	1	30778
 门缝装饰盖板, 适用门板高度1200-2200mm, 氧化铝, 长2200mm	1	31230
 盖板固定夹, 2200mm, 塑料, 黑色, 8件/套	1	31502

全套配件包括:

导轨套装配件, 适用于三门系统, 氧化铝

		编号
Hawa Folding Concepta III 20/25, 导轨套装配件, 三门, 左, 氧化铝		31516
Hawa Folding Concepta III 20/25, 导轨套装配件, 三门, 右, 氧化铝		31517

全套配件包括:

		31516	31517	编号
	顶部导轨, 左上角, 氧化铝, 长820mm	1		31339
	前导轨, 氧化铝, 长1954mm	1	1	31341
	弧形导轨, 左, 氧化铝	1		31365
	底部导轨, 左, 820mm, 氧化铝	1		31336
	口袋连接器, 左上角, 长788mm	1		31370
	顶部口袋连接器咬合杆, 铝, 长660mm	1	1	30977
	底部导轨连接件, 塑料, 黑色, 长94mm	3	3	31086
	弧形导轨连接件, 镀锌钢	1	1	31543
	顶部导轨支撑件, 塑料, 黑色	1	1	31359
	顶部承重轨道适配器, 塑料, 炭黑色, 6件/套	1	1	24870
	三门系统专用门板止位器, 适用推拉款和推弹款	1	1	31538
	顶部承重轨道适配器沉头螺丝, 4.5×16mm, 16件/套	1	1	31587

续表见下一栏

接上一栏

	顶部导轨, 右上角, 氧化铝, 长820mm	1		31340
	弧形导轨, 右, 氧化铝	1		31366
	底部导轨, 右, 820mm, 氧化铝	1		31337
	口袋连接器, 右上角, 长788mm	1		31371

导轨套装配件, 适用两门/四门, 氧化铝, 黑色

	编号
Hawa Folding Concepta III 20/25, 导轨套装配件, 两门, 左, 氧化铝, 黑色	31521
Hawa Folding Concepta III 20/25, 导轨套装配件, 两门, 右, 氧化铝, 黑色	31522
Hawa Folding Concepta III 20/25, 导轨套装配件, 四门, 氧化铝, 黑色	31525

全套配件包括:

	31521	31522	31525	编号
 顶部导轨, 左上角, 氧化铝, 长820mm	1	1		31339
 前导轨, 氧化铝, 长1272mm	1	1		31211
 弧形导轨, 左, 氧化铝, 黑色	1		1	31367
 底部导轨, 左, 820mm, 氧化铝	1		1	31336
 口袋连接器, 左上角, 长788mm	1		1	31370
 顶部口袋连接器咬合杆, 铝, 长660mm	1	1	2	30977
 底部导轨连接件, 塑料, 黑色, 长94mm	3	3	6	31086
 弧形导轨连接件, 镀锌钢	1	1	2	31543
 顶部导轨支撑件, 塑料, 黑色	1	1	2	31359
 顶部承重轨道适配器, 塑料, 炭黑色, 4件/套	1	1	2	23645
 顶部承重轨道适配器沉头螺丝, 4.5x16mm, 16件/套	1	1	2	31585



接上一栏

 修补笔, 黑色	1	1	1	52117
 顶部导轨, 右上角, 氧化铝, 长820mm		1	1	31340
 弧形导轨, 右, 氧化铝, 黑色		1	1	31368
 底部导轨, 右, 820mm, 氧化铝		1	1	31337
 口袋连接器, 右上角, 长788mm		1	1	31371
 前导轨, 氧化铝, 黑色, 长2539mm			1	31344

立柱套装配件, 氧化铝, 黑色

	编号
Hawa Folding Concepta III 20, 立柱, 高:1200-2200mm, 氧化铝, 黑色	31526

全套配件包括:

	31526	编号
 立柱, 适用门板高度1200-2200mm, 氧化铝	1	30778
 门缝装饰盖板, 适用门板高度1200-2200mm, 氧化铝, 黑色, 长2200mm	1	31231
 盖板固定夹, 2200mm, 塑料, 黑色, 8件/套	1	31502

续表见下一栏



导轨套装配件, 适用于三门系统, 氧化铝, 黑色

	编号
Hawa Folding Concepta III 20/25, 导轨套装配件, 三门, 左, 氧化铝, 黑色	31523
Hawa Folding Concepta III 20/25, 导轨套装配件, 三门, 右, 氧化铝, 黑色	31524

全套配件包括:

	31523	31524	编号
 顶部导轨, 左上角, 氧化铝, 长820mm	1		31339
 前导轨, 氧化铝, 黑色, 长1954mm	1	1	31342
 弧形导轨, 左, 氧化铝, 黑色	1		31367
 底部导轨, 左, 820mm, 氧化铝	1		31336
 口袋连接器, 左上角, 长788mm	1		31370
 顶部口袋连接器咬合杆, 铝, 长660mm	1	1	30977
 底部导轨连接件, 塑料, 黑色, 长94mm	3	3	31086
 弧形导轨连接件, 镀锌钢	1	1	31543
 顶部导轨支撑件, 塑料, 黑色	1	1	31359
 顶部承重轨道适配器, 塑料, 炭黑色, 6件/套	1	1	24870
 三门系统专用门板止位器, 适用推拉款和推弹款	1	1	31538
 顶部承重轨道适配器沉头螺丝, 4.5x16mm, 16件/套	1	1	31587

接上一栏

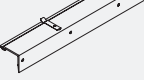
 修补笔, 黑色	1	1	52117
 顶部导轨, 右上角, 氧化铝, 长820mm		1	31340
 弧形导轨, 右, 氧化铝, 黑色		1	31368
 底部导轨, 右, 820mm, 氧化铝		1	31337
 口袋连接器, 右上角, 长788mm		1	31371

续表见下一栏



加固配件

		编号
	加固配件, 2765mm, 适用四门, 氧化铝	52109
	加固配件, 2085mm, 适用三门, 氧化铝	52110

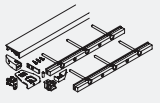
底座配件

		编号
	底座配件套装, 两门, 氧化铝	52089
	底座配件套装, 三门, 氧化铝	52090
	底座配件套装, 四门, 氧化铝	52091
	底座配件套装, 两门, 氧化铝, 黑色	52092
	底座配件套装, 三门, 氧化铝, 黑色	52093
	底座配件套装, 四门, 氧化铝, 黑色	52094

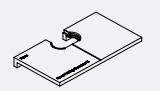
选装配件

		编号
	折叠门铰链开孔模具	52121
	门板找平装置(带磁性), 带钻孔模板, 氧化铝	24006

门板拉直器

→ 在第323页的附件中查找详细信息
铝, 未经处理

		编号
	门板拉直器, 1715-2275mm, 铝	056.3192.079
	门板拉直器, 1215-1775mm, 铝	056.3192.073

氧化铝

		编号
	门板拉直器, 1775-2275mm, 氧化铝, 可调节尺寸, 适用于1215-1712mm的门板	056.3192.080

氧化铝, 黑色

		编号
	门板拉直器, 1715-2275mm, 氧化铝, 黑色	056.3192.081
	门板拉直器, 1215-1775mm, 氧化铝, 黑色	056.3192.076

门板拉直器

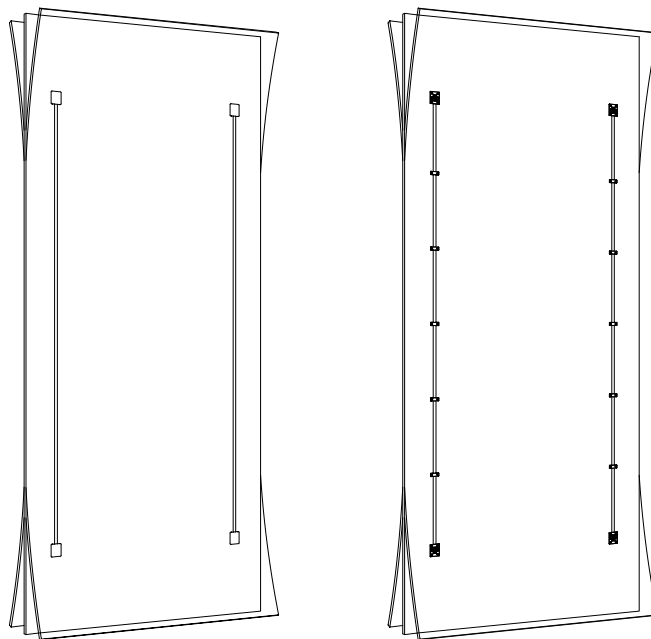

更多安装示例
两门/四门系统外盖门,带底座型材

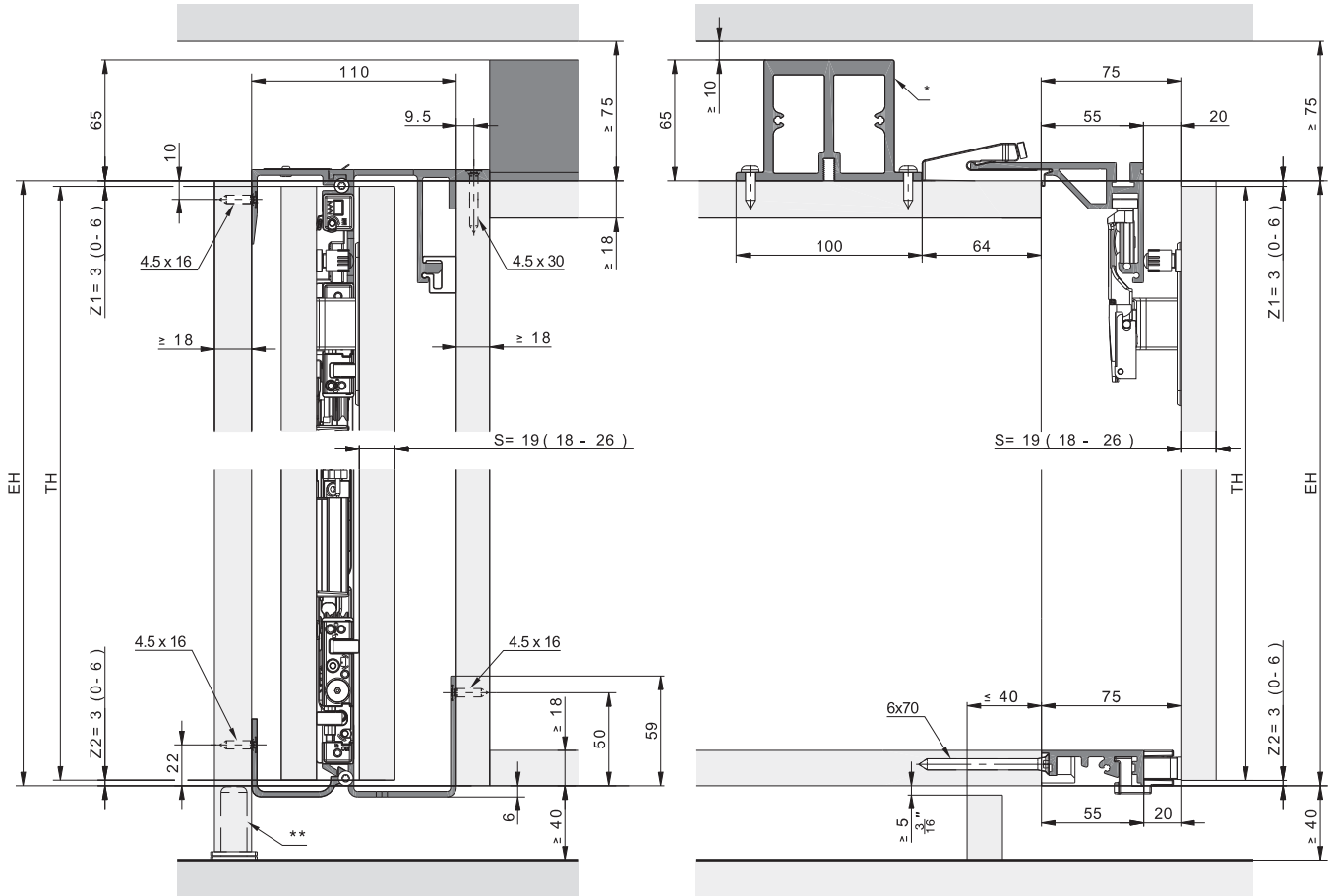

- * 加固配件适用于无中竖板的三门和四门系统
- ** 建议:使用调节脚

一门到顶无底板
两门/四门系统

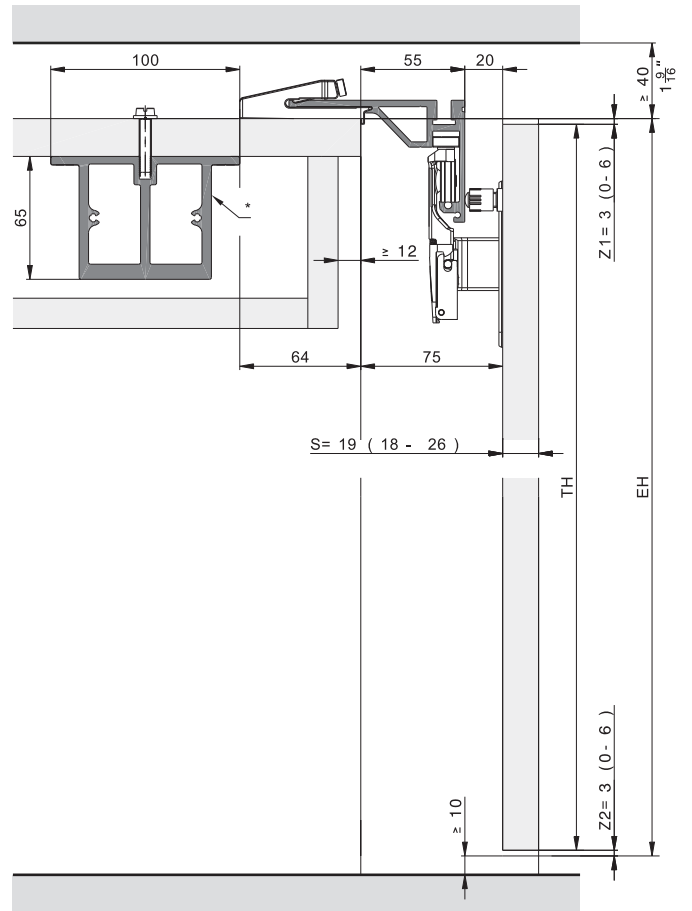
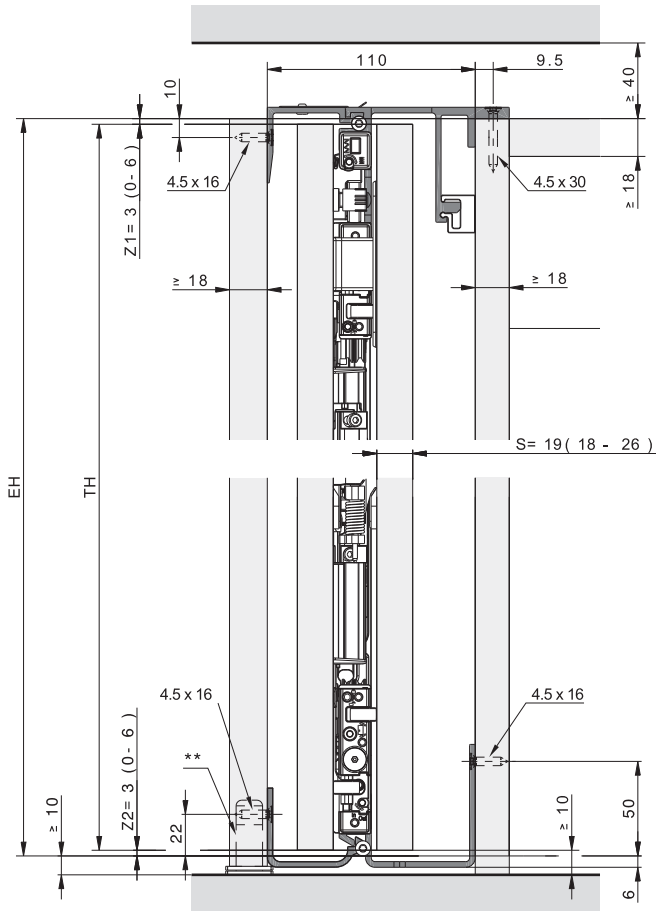

- * 加固配件适用于无中竖板的三门和四门系统
- ** 建议:使用调节脚

三门系统外盖门, 无底座型材

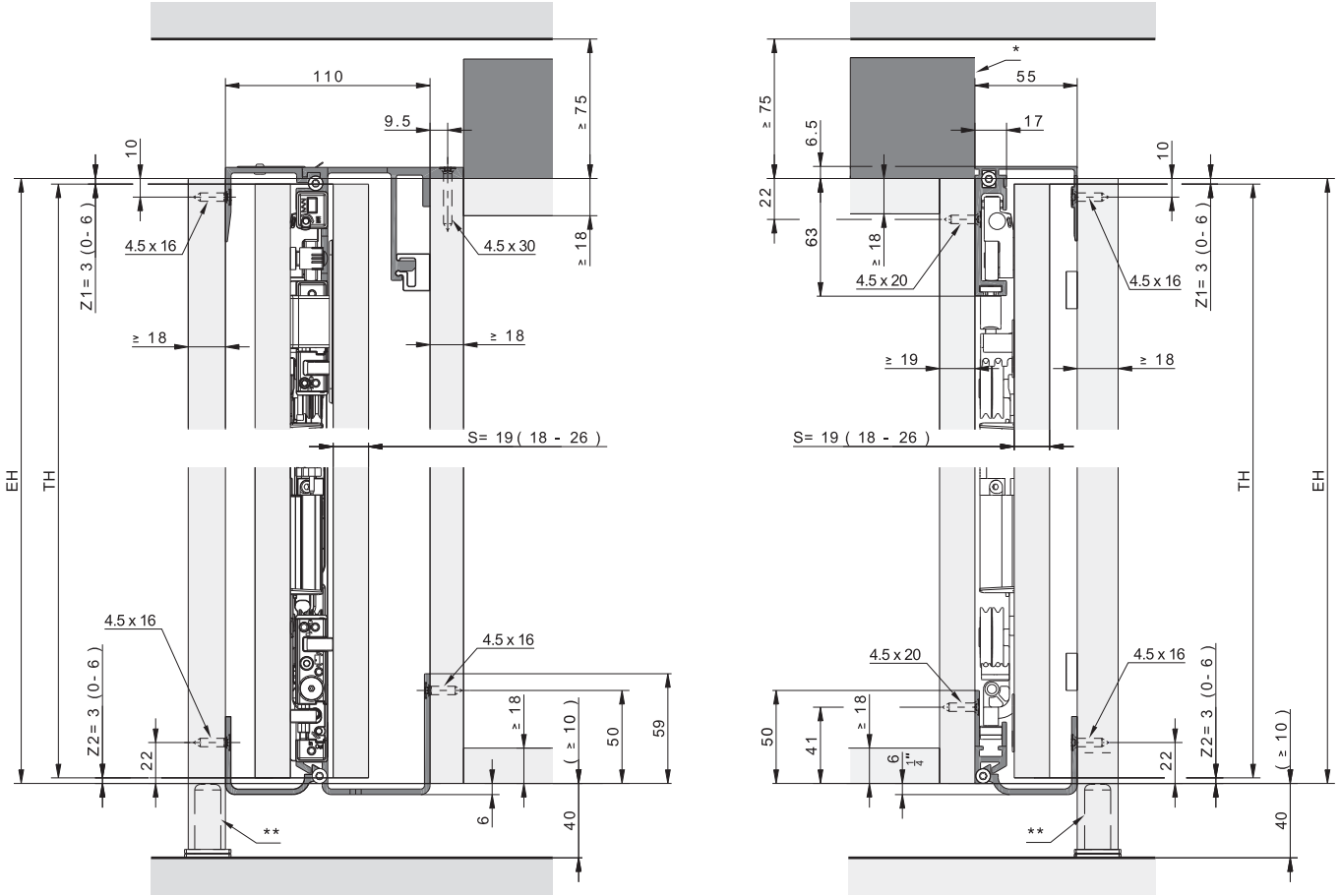

- * 加固配件适用于无中竖板的三门和四门系统
- ** 建议:使用调节脚

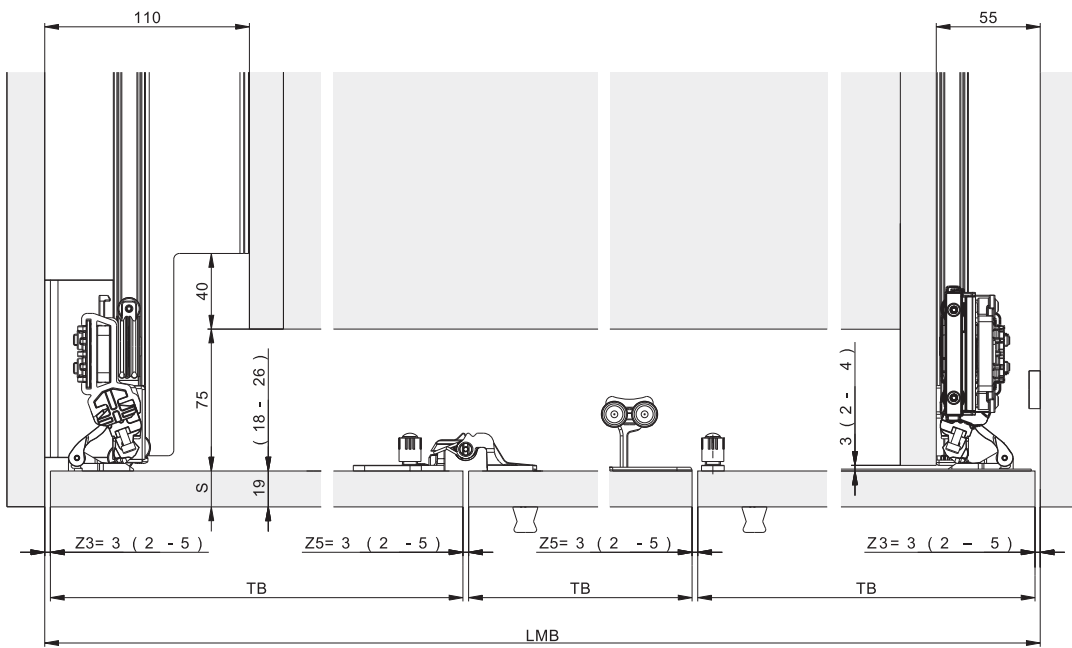

安装深度计算

门板平外侧板

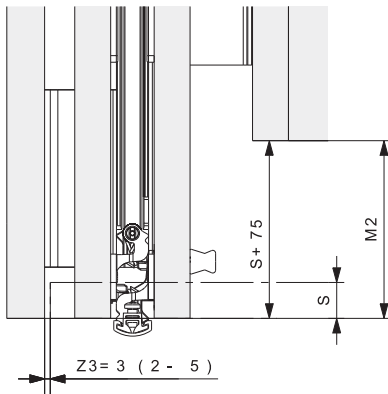

门板凸出外侧板

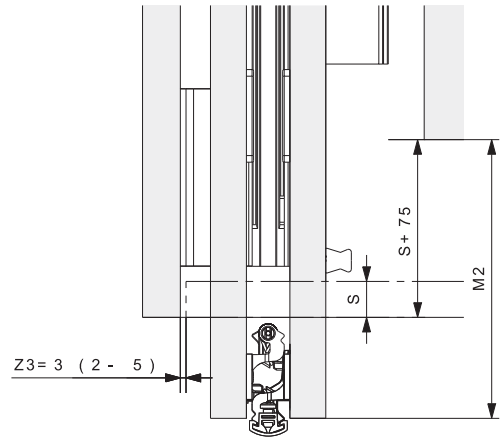

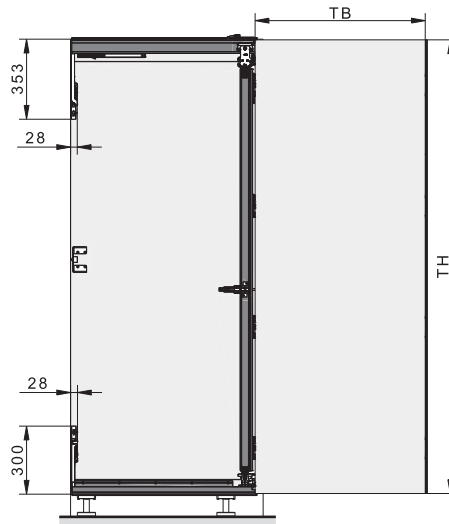
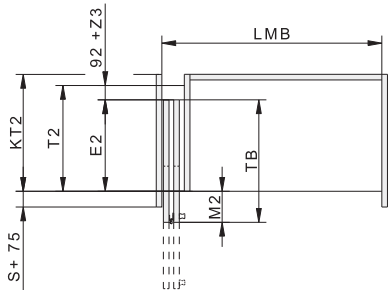

	mm
T2	$TB + 92 + Z3 - M2$
E2	$TB - M2$
KT2	$\geq T2$
M2	$\geq S + 75$ $\leq TB - 390$



- S = 门板厚度
- Z = 门缝
- E2 = 可推入深度
- T2 = 配件深度
- TB = 门板宽度
- TH = 门板高度
- KT2 = 柜体深度
- LMB = 柜体净宽
- M2 = 门板凸出柜体距离

适用于25kg旋转推入式折叠木门的五金件。统一,齐平的门板设计搭配均匀的门缝。
推弹开启功能实现无拉手的柜体设计。

产品亮点

-  **灵活** 多种门板尺寸,适用于落地式、步入式衣柜,可搭配Hawa Concepta III
-  **高效** 得益于高度的预组装和简单的调节,安装更便捷
-  **美观** 无把手柜体设计 —— 隐藏设计带来整洁外观

技术标准

-  门板重量 10-25kg
-  门板高度 1900-2700mm
-  门板宽度 440-750mm
-  门板厚度 18-26mm

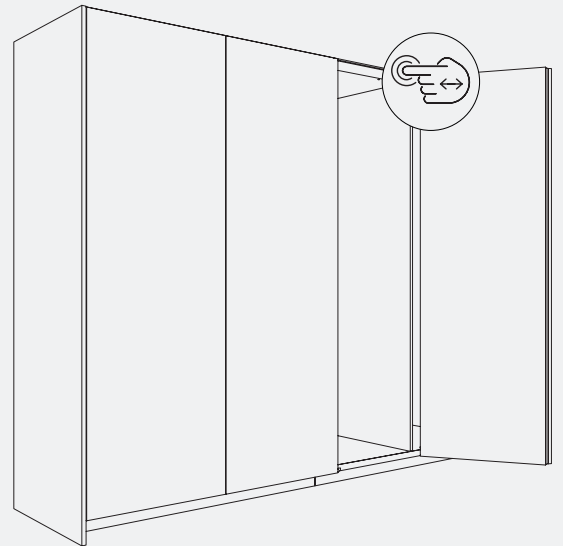

安装示例
外盖门,无底座型材

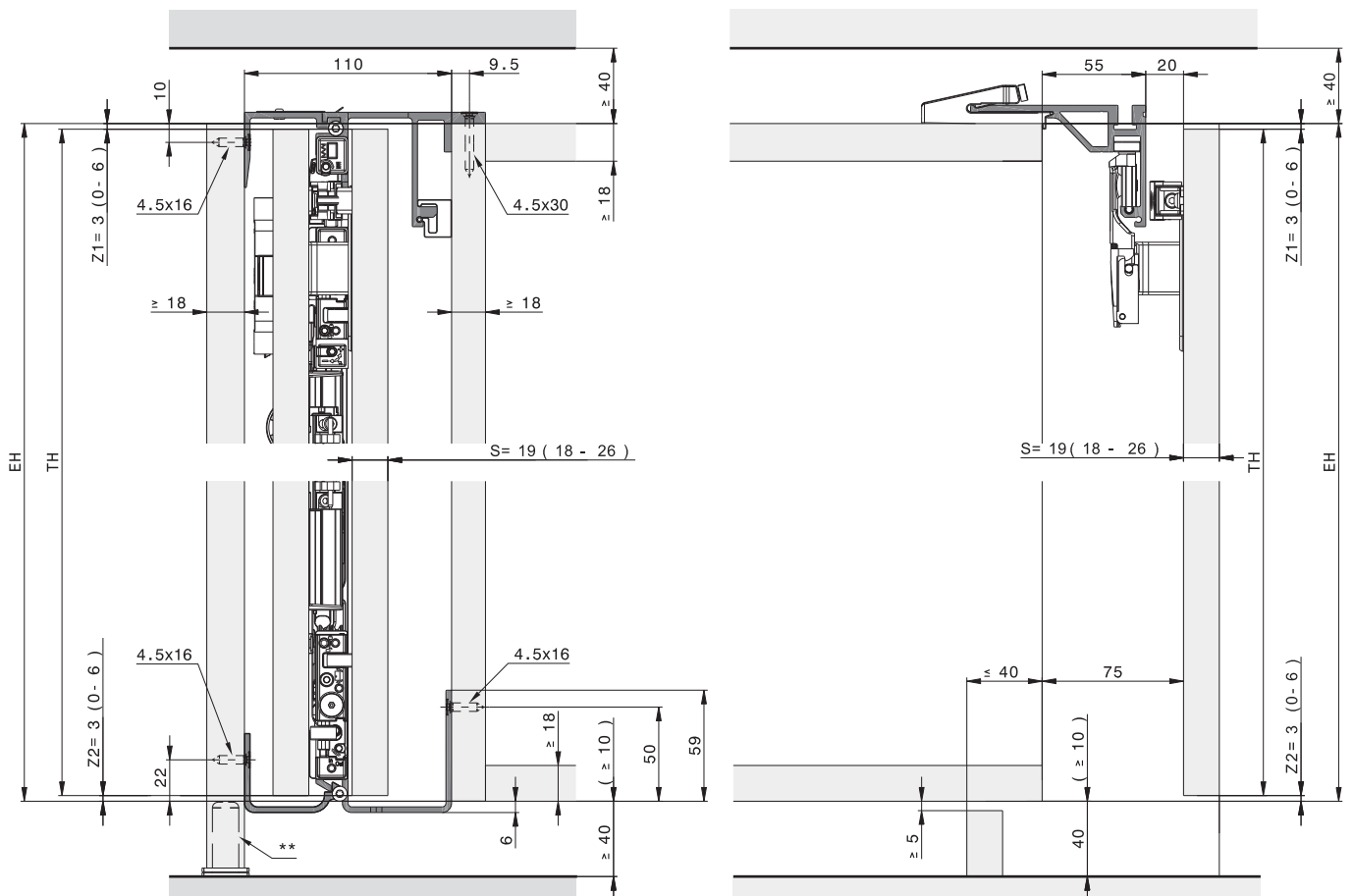

** 建议:使用调节脚

两门/四门系统外盖门, 无底座型材

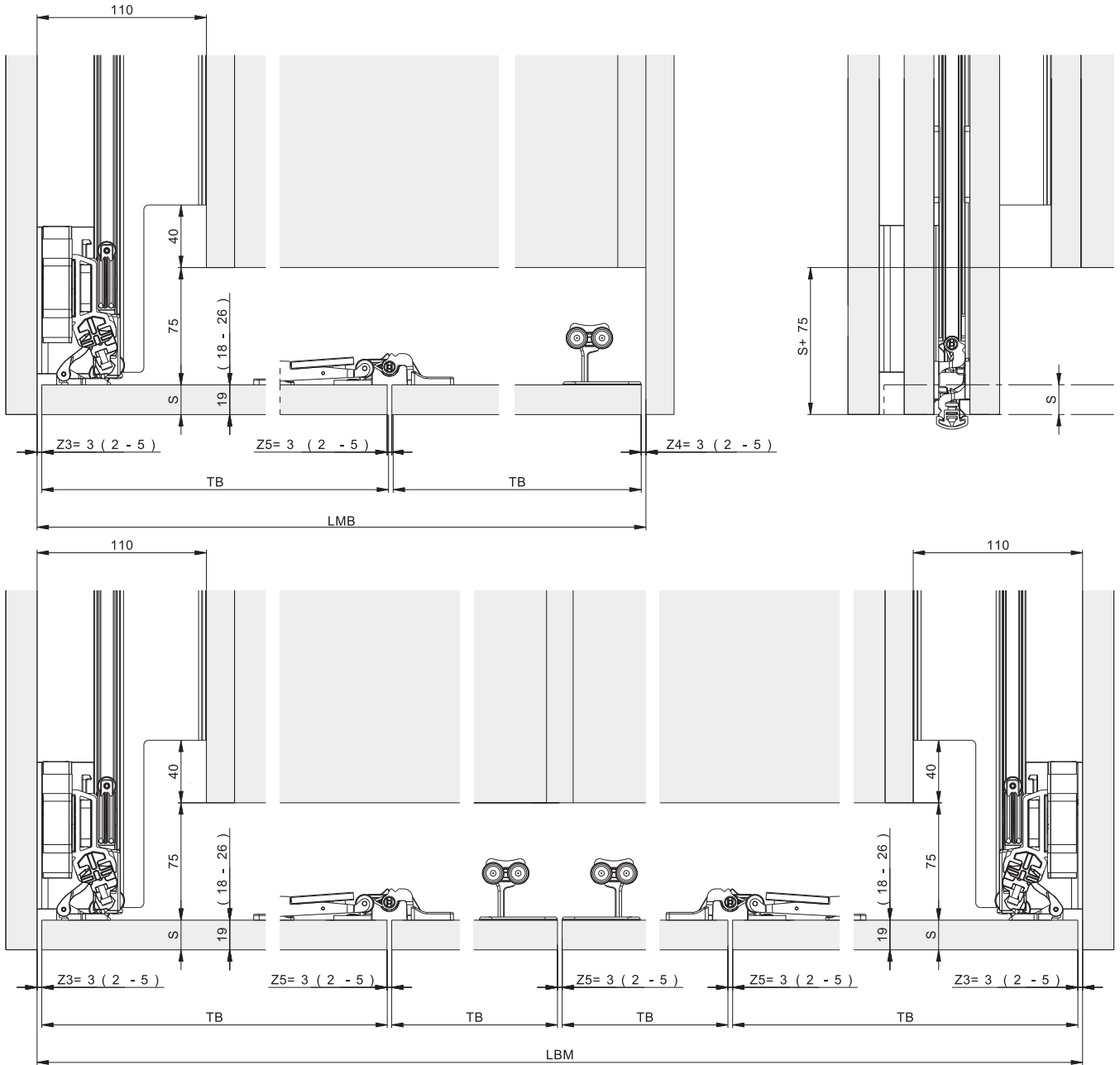

所需部件

两门系统

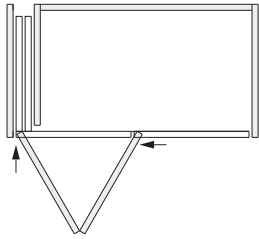

Hawa Folding Concepta III 25 Push, 左, 氧化铝

	编号
Hawa Folding Concepta III 25 Push, 基础套装配件, 高:1900-2700mm	31505
Hawa Folding Concepta III 25 Push, 推弹款滑轮组套装配件, 左	31510
Hawa Folding Concepta III 20/25, 导轨套装配件, 两门, 左, 氧化铝	31514
Hawa Folding Concepta III 25, 立柱, 高:1900-2700mm, 氧化铝	31520

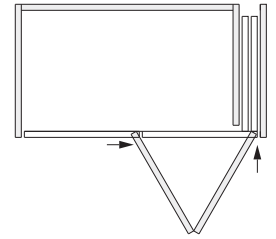

Hawa Folding Concepta III 25 Push, 右, 氧化铝

	编号
Hawa Folding Concepta III 25 Push, 基础套装配件, 高:1900-2700mm	31505
Hawa Folding Concepta III 25 Push, 推弹款滑轮组套装配件, 右	31511
Hawa Folding Concepta III 20/25, 导轨套装配件, 两门, 右, 氧化铝	31515
Hawa Folding Concepta III 25, 立柱, 高:1900-2700mm, 氧化铝	31520

氧化铝, 黑色

	编号
Hawa Folding Concepta III 25 Push, 基础套装配件, 高:1900-2700mm	31505
Hawa Folding Concepta III 25 Push, 推弹款滑轮组套装配件, 左	31510
Hawa Folding Concepta III 20/25, 导轨套装配件, 两门, 左, 氧化铝, 黑色	31521
Hawa Folding Concepta III 25, 立柱, 高:1900-2700mm, 氧化铝, 黑色	31527

氧化铝, 黑色

	编号
Hawa Folding Concepta III 25 Push, 基础套装配件, 高:1900-2700mm	31505
Hawa Folding Concepta III 25 Push, 推弹款滑轮组套装配件, 右	31511
Hawa Folding Concepta III 20/25, 导轨套装配件, 两门, 右, 氧化铝, 黑色	31522
Hawa Folding Concepta III 25, 立柱, 高:1900-2700mm, 氧化铝, 黑色	31527

四门系统

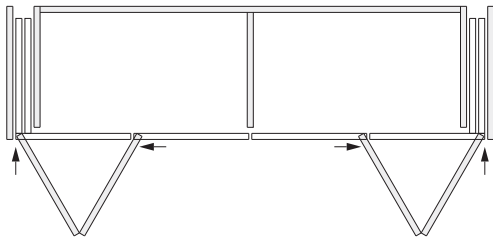

Hawa Folding Concepta III 25 Push, 左/右, 氧化铝

	数量	编号
Hawa Folding Concepta III 25 Push, 基础套装配件, 高:1900-2700mm	2	31505
Hawa Folding Concepta III 25 Push, 推弹款滑轮组套装配件, 左	1	31510
Hawa Folding Concepta III 25 Push, 推弹款滑轮组套装配件, 右	1	31511
Hawa Folding Concepta III 20/25, 导轨套装配件, 四门, 氧化铝	1	31518
Hawa Folding Concepta III 25, 立柱, 高:1900-2700mm, 氧化铝	2	31520

氧化铝, 黑色

	数量	编号
Hawa Folding Concepta III 25 Push, 基础套装配件, 高:1900-2700mm	2	31505
Hawa Folding Concepta III 25 Push, 推弹款滑轮组套装配件, 左	1	31510
Hawa Folding Concepta III 25 Push, 推弹款滑轮组套装配件, 右	1	31511
Hawa Folding Concepta III 20/25, 导轨套装配件, 四门, 氧化铝, 黑色	1	31525
Hawa Folding Concepta III 25, 立柱, 高:1900-2700mm, 氧化铝, 黑色	2	31527

三门系统

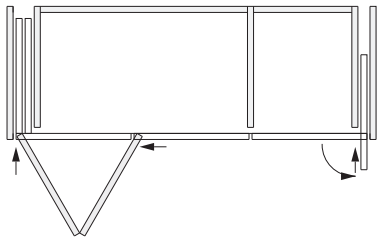

Hawa Folding Concepta III 25 Push, 左,
Hawa Concepta III 35 Push, 右, 氧化铝

	编号
Hawa Folding Concepta III 25 Push, 基础套装配件, 高:1900-2700mm	31505
Hawa Folding Concepta III 25 Push, 推弹款滑轮组套装配件, 左	31510
Hawa Folding Concepta III 20/25, 导轨套装配件, 三门, 左, 氧化铝	31516
Hawa Folding Concepta III 25, 立柱, 高:1900-2700mm, 氧化铝	31520
Hawa Concepta III 35 Push/Pull, 回旋推拉门基础套装配件, 右, 高:1900-2700mm	30997
Hawa Concepta III 25/35 Push, 回旋推拉门推弹套装配件, 右	30999
立柱, 适用门板高度1900-2700mm, 氧化铝	30771
55mm口袋连接器, 用于从外部连接柜体	31005

氧化铝, 黑色

	编号
Hawa Folding Concepta III 25 Push, 基础套装配件, 高:1900-2700mm	31505
Hawa Folding Concepta III 25 Push, 推弹款滑轮组套装配件, 左	31510
Hawa Folding Concepta III 20/25, 导轨套装配件, 三门, 左, 氧化铝, 黑色	31523
Hawa Folding Concepta III 25, 立柱, 高:1900-2700mm, 氧化铝, 黑色	31527
Hawa Concepta III 35 Push/Pull, 回旋推拉门基础套装配件, 右, 高:1900-2700mm	30997
Hawa Concepta III 25/35 Push, 回旋推拉门推弹套装配件, 右	30999
立柱, 适用门板高度1900-2700mm, 氧化铝	30771
55mm口袋连接器, 用于从外部连接柜体	31005

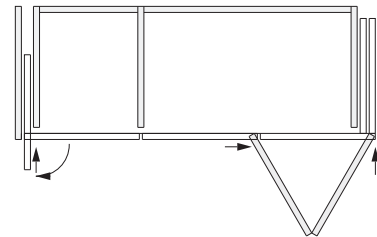

Hawa Folding Concepta III 25 Push, 右,
Hawa Concepta III 35 Push, 左, 氧化铝

	编号
Hawa Folding Concepta III 25 Push, 基础套装配件, 高:1900-2700mm	31505
Hawa Folding Concepta III 25 Push, 推弹款滑轮组套装配件, 右	31511
Hawa Folding Concepta III 20/25, 导轨套装配件, 三门, 右, 氧化铝	31517
Hawa Folding Concepta III 25, 立柱, 高:1900-2700mm, 氧化铝	31520
Hawa Concepta III 35 Push/Pull, 回旋推拉门基础套装配件, 左, 高:1900-2700mm	30996
Hawa Concepta III 25/35 Push, 回旋推拉门推弹套装配件, 左	30998
立柱, 适用门板高度1900-2700mm, 氧化铝	30771
55mm口袋连接器, 用于从外部连接柜体	31005

氧化铝, 黑色

	编号
Hawa Folding Concepta III 25 Push, 基础套装配件, 高:1900-2700mm	31505
Hawa Folding Concepta III 25 Push, 推弹款滑轮组套装配件, 右	31511
Hawa Folding Concepta III 20/25, 导轨套装配件, 三门, 右, 氧化铝, 黑色	31524
Hawa Folding Concepta III 25, 立柱, 高:1900-2700mm, 氧化铝, 黑色	31527
Hawa Concepta III 35 Push/Pull, 回旋推拉门基础套装配件, 左, 高:1900-2700mm	30996
Hawa Concepta III 25/35 Push, 回旋推拉门推弹套装配件, 左	30998
立柱, 适用门板高度1900-2700mm, 氧化铝	30771
55mm口袋连接器, 用于从外部连接柜体	31005

Hawa 配置器

www.hawa.com/configurator →

套装包含的单独部件列表

25kg折叠回旋移门基础套装配件

		编号	
Hawa Folding Concepta III 25 Push, 基础套装配件, 高:1900-2700mm		31505	
		31505	编号
全套配件包括:			
	隐藏式铰链固定件, 塑料, 黑色	4	30686
	铰链限位器, 高度可调, 镀镍钢	1	30738
	隐藏式铰链, 不带关门阻尼和自闭弹簧, 镀镍钢	4	31435
	带弹簧的隐藏式中心铰链, 钢, 镀镍哑光	4	30794
	隐藏式铰链和隐藏式中心铰链专用螺丝, 4×16mm, 26个/套	1	31533
	折叠门承重轮, 镀镍	1	31313
	折叠门承重轮铰链	1	31314
	折叠门推弹器和关门阻尼专用螺丝套装	1	31531
	折叠门关门阻尼	1	31064
	折叠门推弹器	1	31332
	折叠门推弹器, 塑料, 黑色	1	31036
	调节工具套装	1	31047
	沉头螺丝, 4.5×16mm, 镀锌钢, 28件/套	1	31529
	顶部导轨和底部口袋连接器螺丝	1	31530

推弹款滑轮组套装配件

		编号		
Hawa Folding Concepta III 25 Push, 推弹款滑轮组套装配件, 左		31510		
Hawa Folding Concepta III 25 Push, 推弹款滑轮组套装配件, 右		31511		
		31510	31511	编号
全套配件包括:				
	Hawa Folding Concepta III 25 Push 推弹组件, 左	1		31002
	推弹装置末端限位支架, 镀锌钢	1	1	31072
	推弹装置, 塑料, 黑色	1	1	31010
	滑轮装置固定器, 塑料, 黑色	1	1	30966
	折叠门推弹器粘接板, 带双面胶带, 银灰色和黑色	1	1	52118
	Hawa Folding Concepta III 25 Push 推弹组件, 右		1	31003

导轨套装配件, 适用于两门/四门, 氧化铝

	编号
Hawa Folding Concepta III 20/25, 导轨套装配件, 两门, 左, 氧化铝	31514
Hawa Folding Concepta III 20/25, 导轨套装配件, 两门, 右, 氧化铝	31515
Hawa Folding Concepta III 20/25, 导轨套装配件, 四门, 氧化铝	31518

全套配件包括:

	31514	31515	31518	编号
 顶部导轨, 左上角, 氧化铝, 长820mm	1		1	31339
 前导轨, 氧化铝, 长1272mm	1	1		31210
 弧形导轨, 左, 氧化铝	1		1	31365
 底部导轨, 左, 820mm, 氧化铝	1		1	31336
 口袋连接器, 左上角, 长788mm	1		1	31370
 顶部口袋连接器咬合杆, 铝, 长660mm	1	1	2	30977
 底部导轨连接件, 塑料, 黑色, 长94mm	3	3	6	31086
 弧形导轨连接件, 镀锌钢	1	1	2	31543
 顶部导轨支撑件, 塑料, 黑色	1	1	2	31359
 顶部承重轨道适配器, 塑料, 炭黑色, 4件/套	1	1	2	23645
 顶部承重轨道适配器沉头螺丝, 4.5×16mm, 16件/套	1	1	2	31585



续表见下一栏

接上一栏

 顶部导轨, 右上角, 氧化铝, 长820mm		1	1	31340
 弧形导轨, 右, 氧化铝		1	1	31366
 底部导轨, 右, 820mm, 氧化铝		1	1	31337
 口袋连接器, 右上角, 长788mm		1	1	31371
 前导轨, 氧化铝, 长1272mm			1	31343

立柱套装配件, 氧化铝

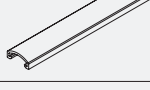
	编号
Hawa Folding Concepta III 25, 立柱, 高:1900-2700mm, 氧化铝	31520

	31520	编号
 立柱, 适用门板高度1900-2700mm, 氧化铝	1	30771
 门缝装饰盖板, 适用门板高度1900-2700mm, 氧化铝, 长2700mm	1	31232
 盖板固定夹, 2700mm, 塑料, 黑色, 8件/套	1	31503

全套配件包括:

导轨套装配件, 适用于三门系统, 氧化铝

	编号
Hawa Folding Concepta III 20/25, 导轨套装配件, 三门, 左, 氧化铝	31516
Hawa Folding Concepta III 20/25, 导轨套装配件, 三门, 右, 氧化铝	31517

全套配件包括:	31516	31517	编号
	 顶部导轨, 左上角, 氧化铝, 长820mm	1	
 前导轨, 氧化铝, 长1954mm	1	1	31341
 弧形导轨, 左, 氧化铝	1		31365
 底部导轨, 左, 820mm, 氧化铝	1		31336
 口袋连接器, 左上角, 长788mm	1		31370
 顶部口袋连接器咬合杆, 铝, 长660mm	1	1	30977
 底部导轨连接件, 塑料, 黑色, 长94mm	3	3	31086
 弧形导轨连接件, 镀锌钢	1	1	31543
 顶部导轨支撑件, 塑料, 黑色	1	1	31359
 顶部承重轨道适配器, 塑料, 灰黑色, 6件/套	1	1	24870
 三门系统专用门板止位器, 适用推拉款和推弹款	1	1	31538
 顶部承重轨道适配器沉头螺丝, 4.5×16mm, 16件/套	1	1	31587

续表见下一栏

接上一栏

	顶部导轨, 右上角, 氧化铝, 长820mm	1	31340
	弧形导轨, 右, 氧化铝	1	31366
	底部导轨, 右, 820mm, 氧化铝	1	31337
	口袋连接器, 右上角, 长788mm	1	31371

导轨套装配件, 适用两门/四门, 氧化铝, 黑色

	编号
Hawa Folding Concepta III 20/25, 导轨套装配件, 两门, 左, 氧化铝, 黑色	31521
Hawa Folding Concepta III 20/25, 导轨套装配件, 两门, 右, 氧化铝, 黑色	31522
Hawa Folding Concepta III 20/25, 导轨套装配件, 四门, 氧化铝, 黑色	31525

全套配件包括:				编号
	31521	31522	31525	
	1	1	1	31339
	1	1	1	31211
	1	1	1	31367
	1	1	1	31336
	1	1	1	31370
	1	1	2	30977
	3	3	6	31086
	1	1	2	31543
	1	1	2	31359
	1	1	2	23645
	1	1	2	31585



续表见下一栏

接上一栏

	修补笔, 黑色	1	1	1	52117
	顶部导轨, 右上角, 氧化铝, 黑色, 长820mm		1	1	31340
	弧形导轨, 右, 氧化铝, 黑色		1	1	31368
	底部导轨, 右, 820mm, 氧化铝		1	1	31337
	口袋连接器, 右上角, 长788mm		1	1	31371
	前导轨, 氧化铝, 黑色, 长2539mm			1	31344

立柱套装配件, 氧化铝, 黑色

	编号
Hawa Folding Concepta III 25, 立柱, 高: 1900-2700mm, 氧化铝, 黑色	31527

全套配件包括:				编号
	31527			
	立柱, 适用门板高度1900-2700mm, 氧化铝	1		30771
	门缝装饰盖板, 适用门板高度1900-2700mm, 氧化铝, 黑色, 长2700mm	1		31233
	盖板固定夹, 2700mm, 塑料, 黑色, 8件/套	1		31503

导轨套装配件, 适用于三门系统, 氧化铝, 黑色

	编号
Hawa Folding Concepta III 20/25, 导轨套装配件, 三门, 左, 氧化铝, 黑色	31523
Hawa Folding Concepta III 20/25, 导轨套装配件, 三门, 右, 氧化铝, 黑色	31524

全套配件包括:

	31523	31524	编号
 顶部导轨, 左上角, 氧化铝, 长820mm	1		31339
 前导轨, 氧化铝, 黑色, 长1954mm	1	1	31342
 弧形导轨, 左, 氧化铝, 黑色	1		31367
 底部导轨, 左, 820mm, 氧化铝	1		31336
 口袋连接器, 左上角, 长788mm	1		31370
 顶部口袋连接器咬合杆, 铝, 长660mm	1	1	30977
 底部导轨连接件, 塑料, 黑色, 长94mm	3	3	31086
 弧形导轨连接件, 镀锌钢	1	1	31543
 顶部导轨支撑件, 塑料, 黑色	1	1	31359
 顶部承重轨道适配器, 塑料, 炭黑色, 6件/套	1	1	24870
 三门系统专用门板止位器, 适用推拉款和推弹款	1	1	31538
 顶部承重轨道适配器沉头螺丝, 4.5x16mm, 16件/套	1	1	31587

接上一栏

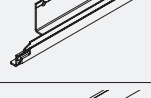
	修补笔, 黑色	1	1	52117
	顶部导轨, 右上角, 氧化铝, 长820mm		1	31340
	弧形导轨, 右, 氧化铝, 黑色		1	31368
	底部导轨, 右, 820mm, 氧化铝		1	31337
	口袋连接器, 右上角, 长788mm		1	31371

续表见下一栏



加固配件

		编号
	加固配件, 2765mm, 适用四门, 氧化铝	52109
	加固配件, 2085mm, 适用三门, 氧化铝	52110

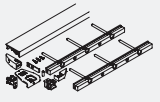
底座配件

		编号
	底座配件套装, 两门, 氧化铝	52089
	底座配件套装, 三门, 氧化铝	52090
	底座配件套装, 四门, 氧化铝	52091
	底座配件套装, 两门, 氧化铝, 黑色	52092
	底座配件套装, 三门, 氧化铝, 黑色	52093
	底座配件套装, 四门, 氧化铝, 黑色	52094

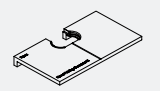
选装配件

		编号
	折叠门铰链开孔模具	52121
	门板找平装置(带磁性), 带钻孔模板, 氧化铝	24006

门板拉直器

→ 在第323页的附件中查找详细信息

铝, 未经处理

		编号
	门板拉直器, 2040-2600mm, 铝	056.3192.072
	门板拉直器, 1715-2275mm, 铝	056.3192.079

氧化铝

		编号
	门板拉直器, 2240-2850mm, 氧化铝	056.3192.071
	门板拉直器, 2040-2600mm, 氧化铝	056.3192.082

氧化铝, 黑色

		编号
	门板拉直器, 2240-2850mm, 氧化铝, 黑色	056.3192.074
	门板拉直器, 2040-2600mm, 氧化铝, 黑色	056.3192.075
	门板拉直器, 1715-2275mm, 氧化铝, 黑色	056.3192.081

门板拉直器

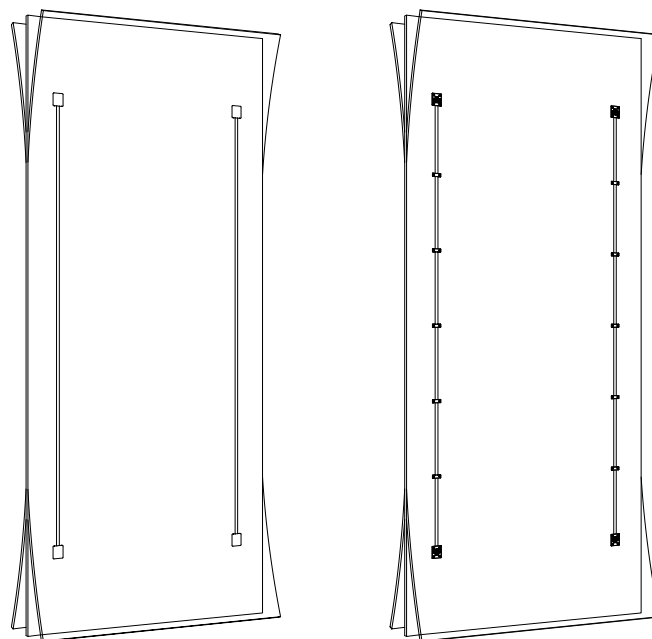

更多安装示例
两门/四门系统外盖门, 带底座型材

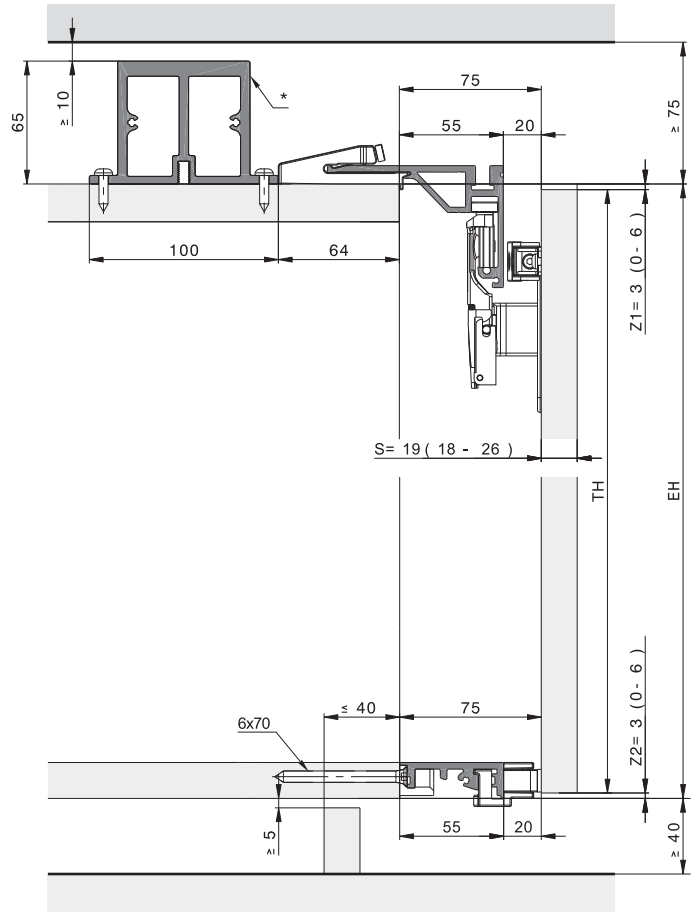
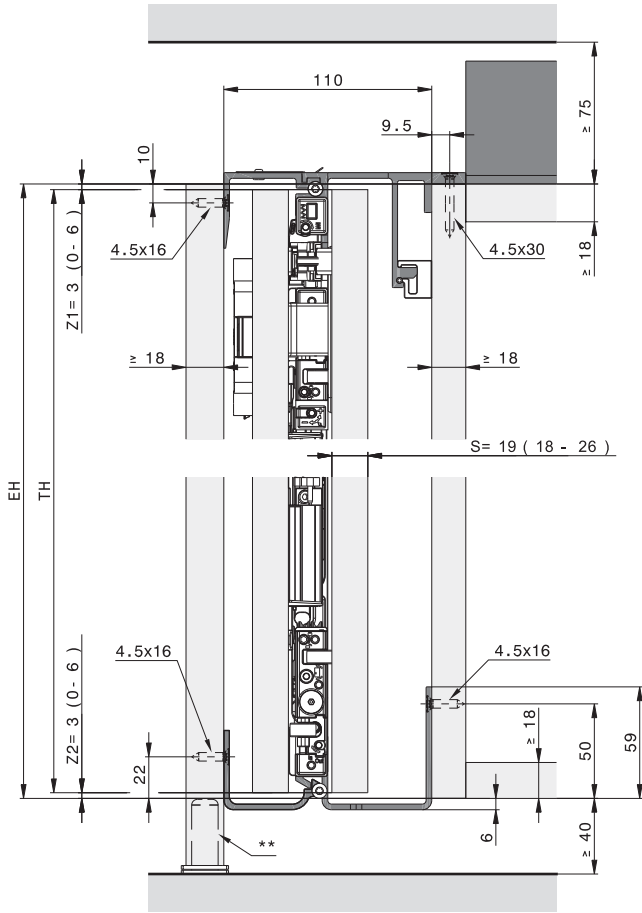

- * 加固配件适用于无中竖板的三门和四门系统
- ** 建议: 使用调节脚

一门到顶无底板
两门/四门系统

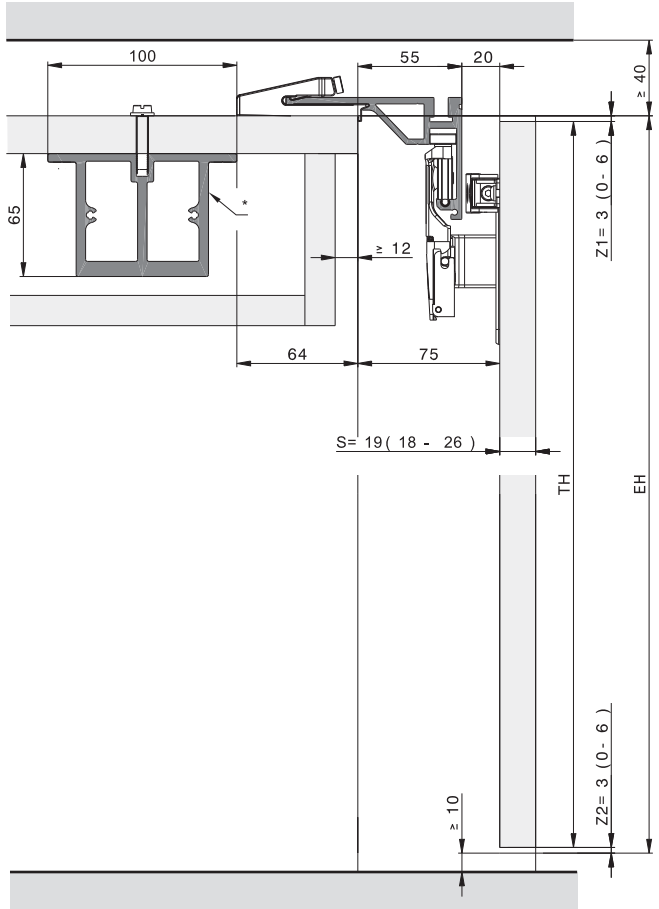
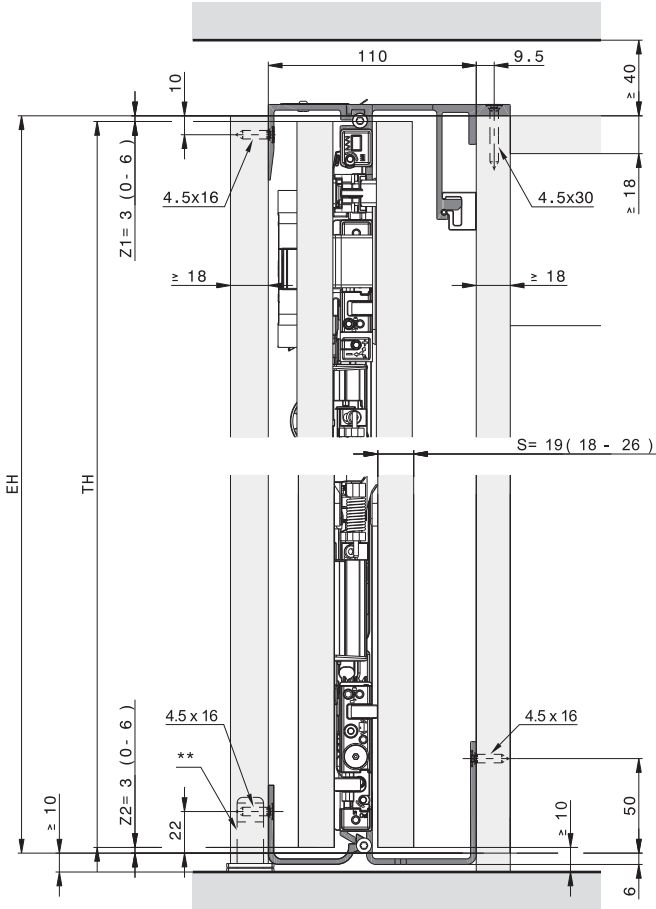

* 加固配件适用于无中竖板的三门和四门系统
 ** 建议:使用调节脚

三门系统外盖门, 无底座型材

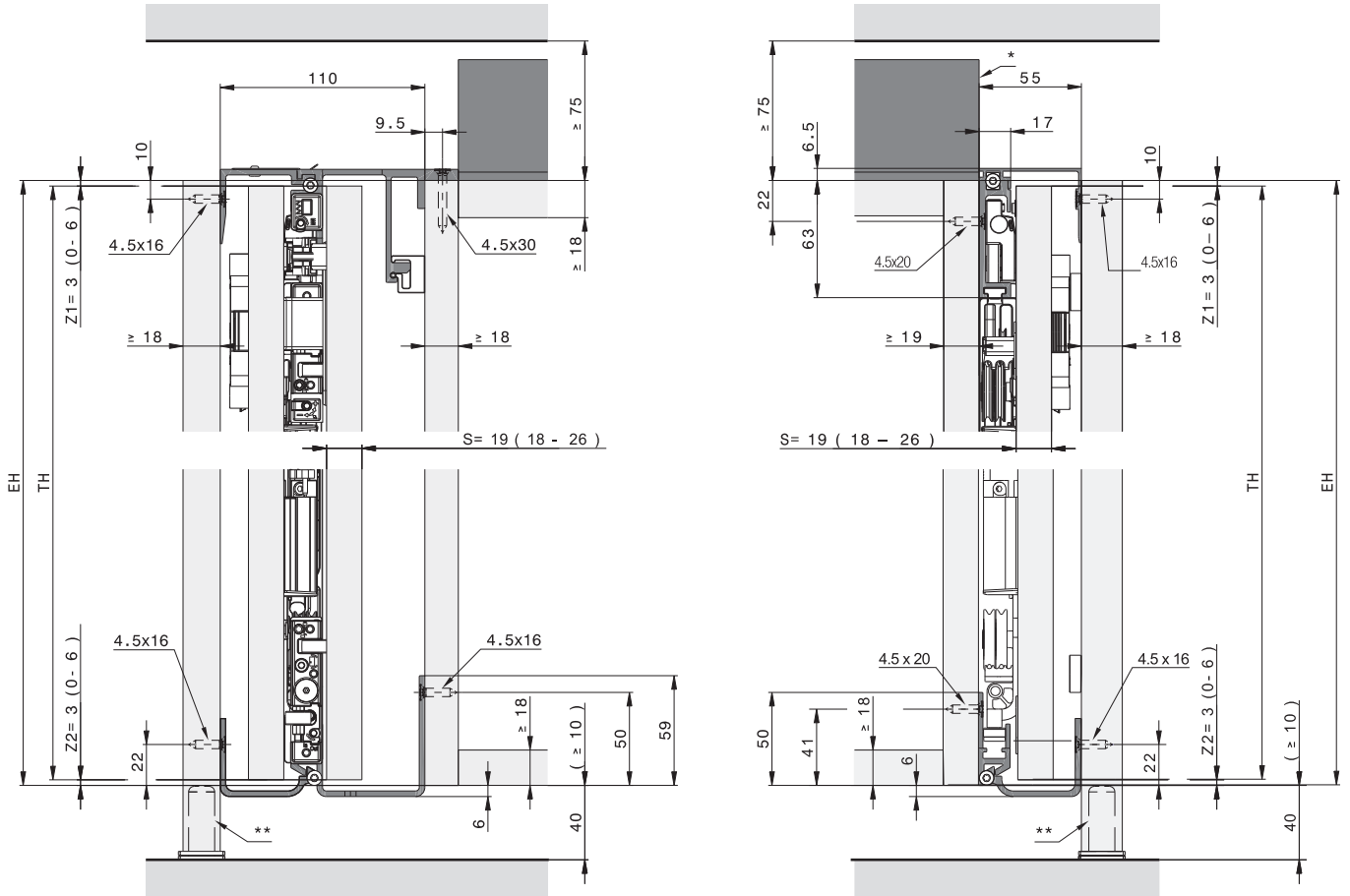

- * 加固配件适用于无中竖板的三门和四门系统
- ** 建议: 使用调节脚

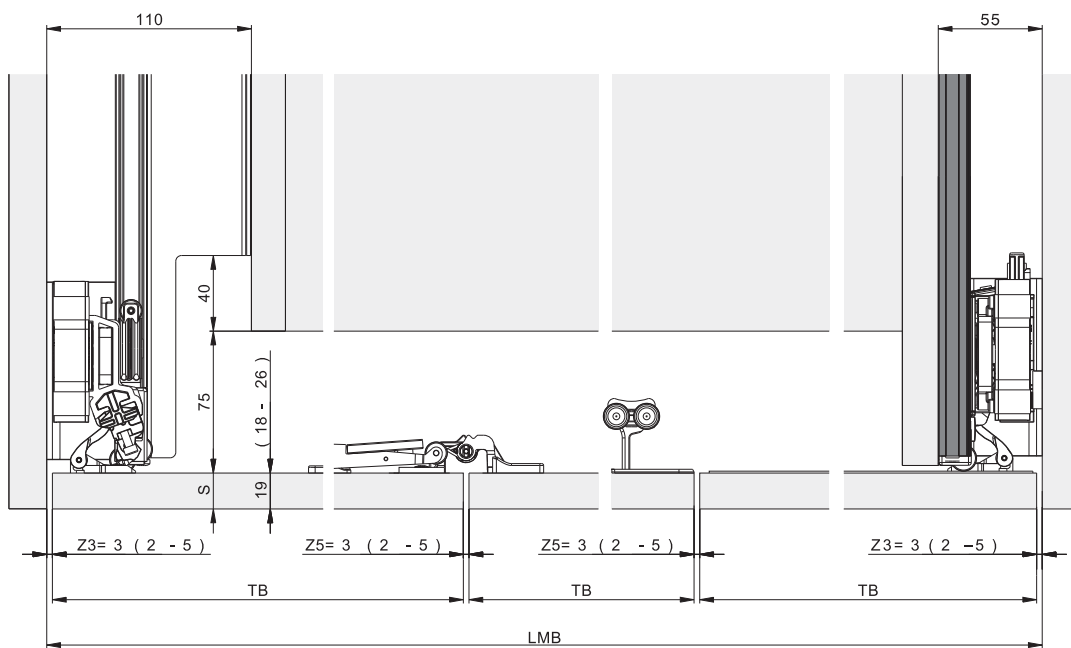

安装深度计算
门板平外侧板

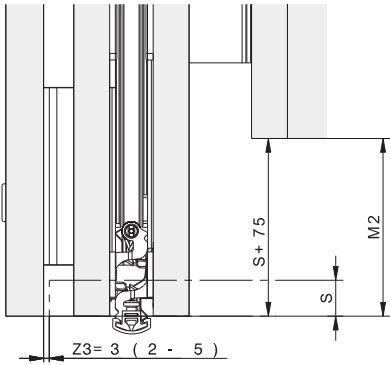

门板凸出外侧板

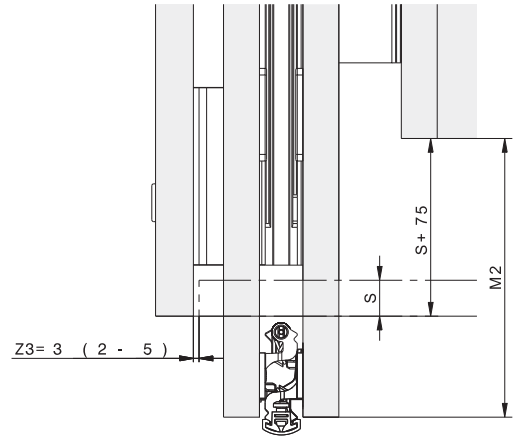

	mm
T2	$TB + 92 + Z3 - M2$
E2	$TB - M2$
KT2	$\geq T2$
M2	$\geq S + 75$ $\leq TB - 390$

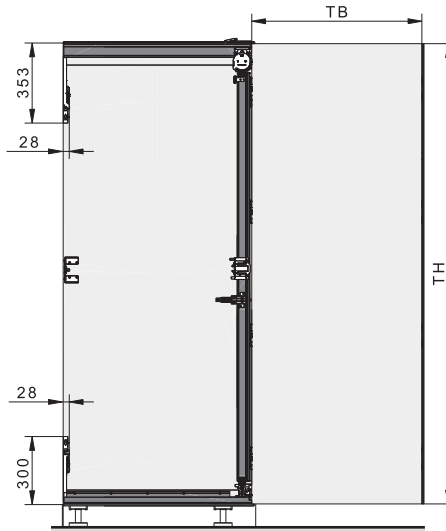
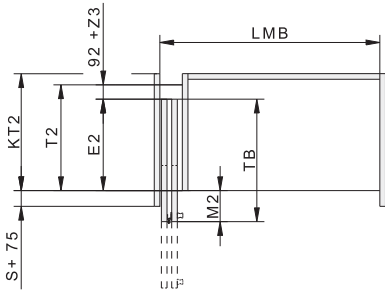

- S = 门板厚度
- Z = 门缝
- E2 = 可推入深度
- T2 = 配件深度
- TB = 门板宽度
- TH = 门板高度
- KT2 = 柜体深度
- LMB = 柜体净宽
- M2 = 门板凸出柜体距离

适用于25kg旋转推入式折叠木门的五金件。统一,齐平的门板设计搭配均匀的门缝。
 隐形设计,带拉手版本。

产品亮点

- 灵活** 多种门板尺寸,适用于落地式、步入式衣柜,可搭配Hawa Concepta III
- 高效** 得益于高度的预组装和简单的调节,安装更便捷
- 舒适** 单手可以轻松打开和关闭

技术标准

- 门板重量** 10-25kg
- 门板高度** 1900-2700mm
- 门板宽度** 440-750mm
- 门板厚度** 18-26mm

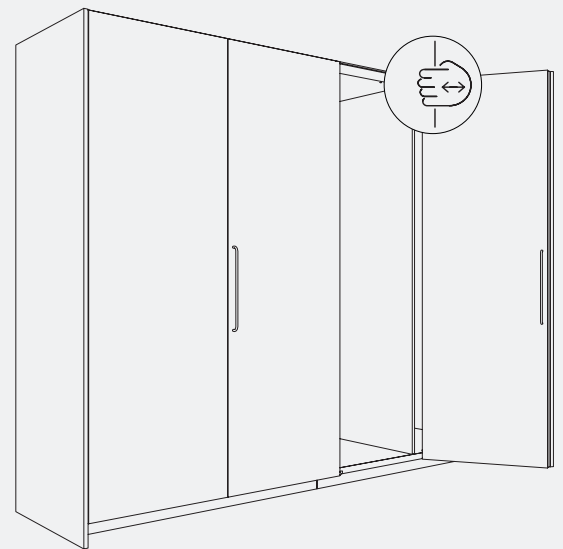

安装示例 外盖门,无底座型材

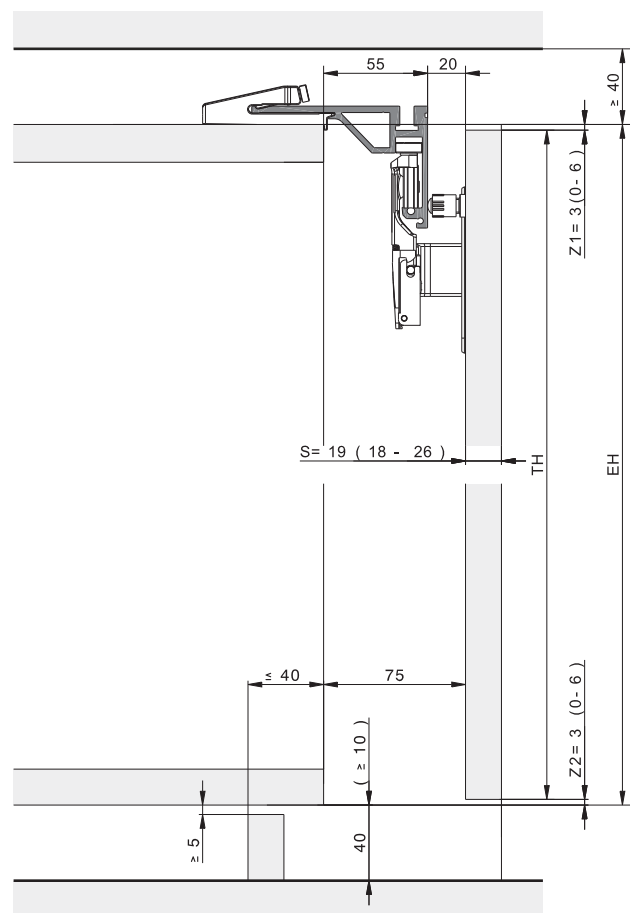
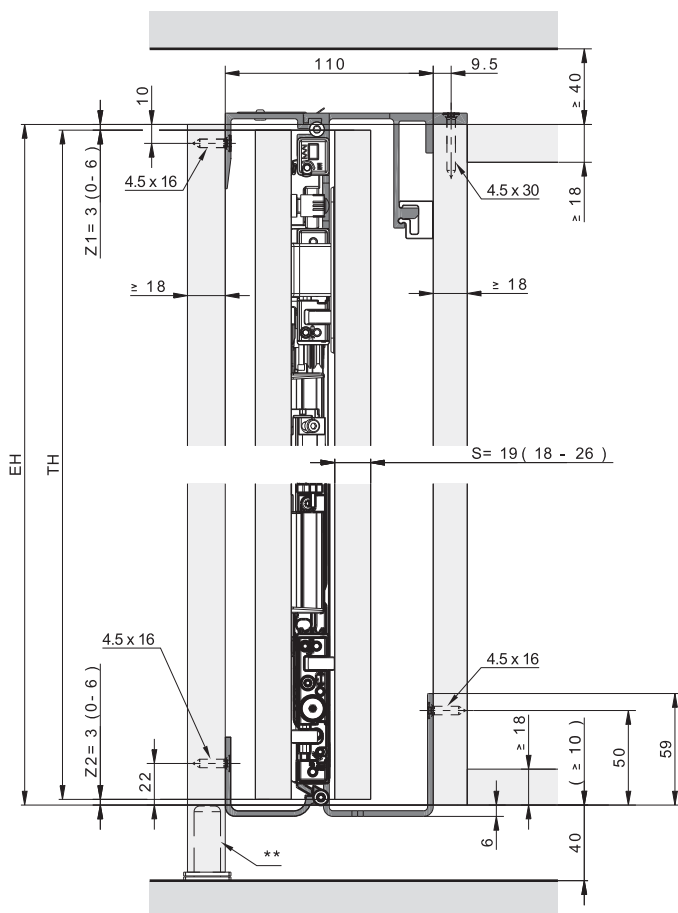

** 建议:使用调节脚

两门/四门系统外盖门, 无底座型材

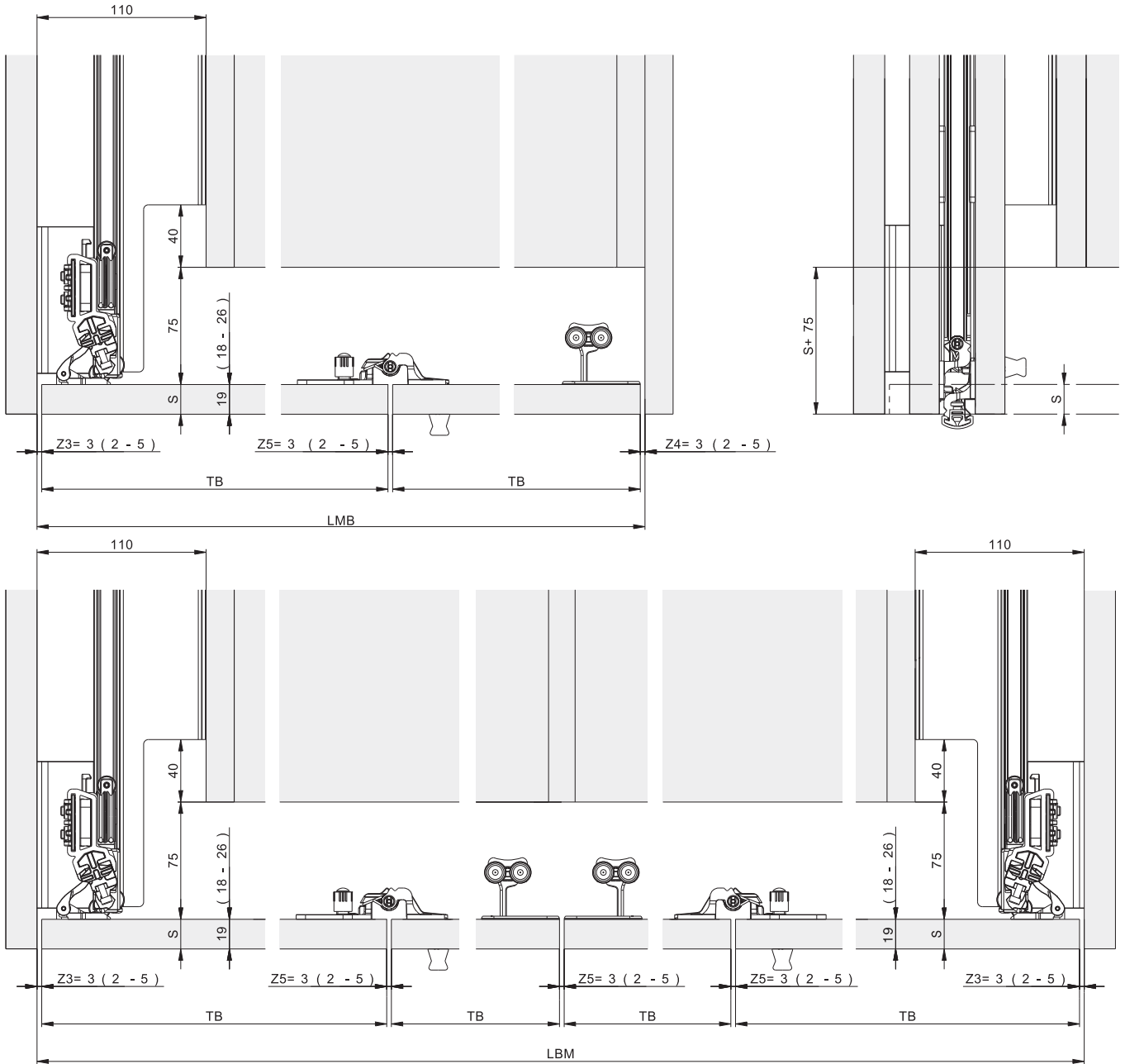

所需部件

两门系统

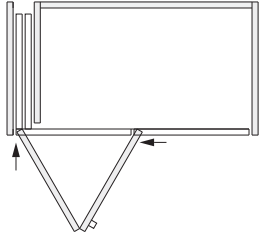

Hawa Folding Concepta III 25 Pull, 左, 氧化铝

	编号
Hawa Folding Concepta III 25 Pull, 基础套装配件, 高:1900-2700mm	31507
Hawa Folding Concepta III 20/25 Pull, 推拉款滑轮组套装配件, 左	31512
Hawa Folding Concepta III 20/25, 导轨套装配件, 两门, 左, 氧化铝	31514
Hawa Folding Concepta III 25, 立柱, 高:1900-2700mm, 氧化铝	31520

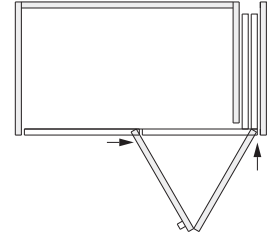

Hawa Folding Concepta III 25 Pull, 右, 氧化铝

	编号
Hawa Folding Concepta III 25 Pull, 基础套装配件, 高:1900-2700mm	31507
Hawa Folding Concepta III 20/25 Pull, 推拉款滑轮组套装配件, 右	31513
Hawa Folding Concepta III 20/25, 导轨套装配件, 两门, 右, 氧化铝	31515
Hawa Folding Concepta III 25, 立柱, 高:1900-2700mm, 氧化铝	31520

氧化铝, 黑色

	编号
Hawa Folding Concepta III 25 Pull, 基础套装配件, 高:1900-2700mm	31507
Hawa Folding Concepta III 20/25 Pull, 推拉款滑轮组套装配件, 左	31512
Hawa Folding Concepta III 20/25, 导轨套装配件, 两门, 左, 氧化铝, 黑色	31521
Hawa Folding Concepta III 25, 立柱, 高:1900-2700mm, 氧化铝, 黑色	31527

氧化铝, 黑色

	编号
Hawa Folding Concepta III 25 Pull, 基础套装配件, 高:1900-2700mm	31507
Hawa Folding Concepta III 20/25 Pull, 推拉款滑轮组套装配件, 右	31513
Hawa Folding Concepta III 20/25, 导轨套装配件, 两门, 右, 氧化铝, 黑色	31522
Hawa Folding Concepta III 25, 立柱, 高:1900-2700mm, 氧化铝, 黑色	31527

四门系统

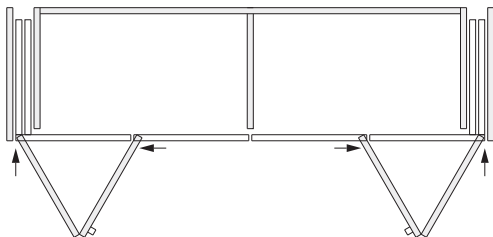

Hawa Folding Concepta III 25 Pull, 左/右, 氧化铝

	数量	编号
Hawa Folding Concepta III 25 Pull, 基础套装配件, 高:1900-2700mm	2	31507
Hawa Folding Concepta III 20/25 Pull, 推拉款滑轮组套装配件, 左	1	31512
Hawa Folding Concepta III 20/25 Pull, 推拉款滑轮组套装配件, 右	1	31513
Hawa Folding Concepta III 20/25, 导轨套装配件, 四门, 氧化铝	1	31518
Hawa Folding Concepta III 25, 立柱, 高:1900-2700mm, 氧化铝	2	31520

氧化铝, 黑色

	数量	编号
Hawa Folding Concepta III 25 Pull, 基础套装配件, 高:1900-2700mm	2	31507
Hawa Folding Concepta III 20/25 Pull, 推拉款滑轮组套装配件, 左	1	31512
Hawa Folding Concepta III 20/25 Pull, 推拉款滑轮组套装配件, 右	1	31513
Hawa Folding Concepta III 20/25, 导轨套装配件, 四门, 氧化铝, 黑色	1	31525
Hawa Folding Concepta III 25, 立柱, 高:1900-2700mm, 氧化铝, 黑色	2	31527

三门系统

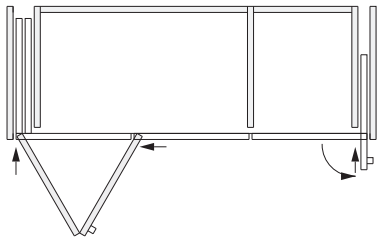

Hawa Folding Concepta III 25 Pull, 左,
Hawa Concepta III 35 Pull, 右, 氧化铝

	编号
Hawa Folding Concepta III 25 Pull, 基础套装配件, 高:1900-2700mm	31507
Hawa Folding Concepta III 20/25 Pull, 推拉款滑轮组套装配件, 左	31512
Hawa Folding Concepta III 20/25, 导轨套装配件, 三门, 左, 氧化铝	31516
Hawa Folding Concepta III 25, 立柱, 高:1900-2700mm, 氧化铝	31520
Hawa Concepta III 35 Push/Pull, 回旋推拉门基础套装配件, 右, 高:1900-2700mm	30997
Hawa Concepta III 25/35 Pull, 回旋推拉门推拉套装配件, 右	31001
立柱, 适用门板高度1900-2700mm, 氧化铝	30771
55mm口袋连接器, 用于从外部连接柜体	31005

氧化铝, 黑色

	编号
Hawa Folding Concepta III 25 Pull, 基础套装配件, 高:1900-2700mm	31507
Hawa Folding Concepta III 20/25 Pull, 推拉款滑轮组套装配件, 左	31512
Hawa Folding Concepta III 20/25, 导轨套装配件, 三门, 左, 氧化铝, 黑色	31523
Hawa Folding Concepta III 25, 立柱, 高:1900-2700mm, 氧化铝, 黑色	31527
Hawa Concepta III 35 Push/Pull, 回旋推拉门基础套装配件, 右, 高:1900-2700mm	30997
Hawa Concepta III 25/35 Pull, 回旋推拉门推拉套装配件, 右	31001
立柱, 适用门板高度1900-2700mm, 氧化铝	30771
55mm口袋连接器, 用于从外部连接柜体	31005

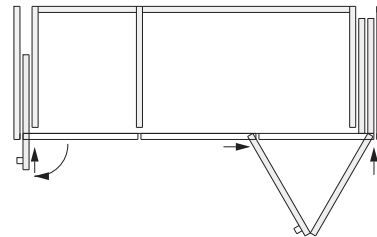

Hawa Folding Concepta III 25 Pull, 右,
Hawa Concepta III 35 Pull, 左, 氧化铝

	编号
Hawa Folding Concepta III 25 Pull, 基础套装配件, 高:1900-2700mm	31507
Hawa Folding Concepta III 20/25 Pull, 推拉款滑轮组套装配件, 右	31513
Hawa Folding Concepta III 20/25, 导轨套装配件, 三门, 右, 氧化铝	31517
Hawa Folding Concepta III 25, 立柱, 高:1900-2700mm, 氧化铝	31520
Hawa Concepta III 35 Push/Pull, 回旋推拉门基础套装配件, 左, 高:1900-2700mm	30996
Hawa Concepta III 25/35 Pull, 回旋推拉门推拉套装配件, 左	31000
立柱, 适用门板高度1900-2700mm, 氧化铝	30771
55mm口袋连接器, 用于从外部连接柜体	31005

氧化铝, 黑色

	编号
Hawa Folding Concepta III 25 Pull, 基础套装配件, 高:1900-2700mm	31507
Hawa Folding Concepta III 20/25 Pull, 推拉款滑轮组套装配件, 右	31513
Hawa Folding Concepta III 20/25, 导轨套装配件, 三门, 右, 氧化铝, 黑色	31524
Hawa Folding Concepta III 25, 立柱, 高:1900-2700mm, 氧化铝, 黑色	31527
Hawa Concepta III 35 Push/Pull, 回旋推拉门基础套装配件, 左, 高:1900-2700mm	30996
Hawa Concepta III 25/35 Pull, 回旋推拉门推拉套装配件, 左	31000
立柱, 适用门板高度1900-2700mm, 氧化铝	30771
55mm口袋连接器, 用于从外部连接柜体	31005

Hawa 配置器

www.hawa.com/configurator →

套装包含的单独部件列表

25kg折叠回旋移门基础套装配件

		编号	
Hawa Folding Concepta III 25 Pull, 基础套装配件, 高:1900-2700mm		31507	
		31507	编号
全套配件包括:			
	隐藏式铰链固定件, 塑料, 黑色	4	30686
	铰链限位器, 高度可调, 镀镍钢	1	30738
	隐藏式铰链, 带关门阻尼和自 闭弹簧, 镀镍钢	4	31070
	带弹簧的隐藏式中心铰链, 钢, 镀镍哑光	4	31362
	隐藏式铰链和隐藏式中心铰链 专用螺丝, 4×16mm, 26个/套	1	31533
	折叠门承重轮, 镀镍	1	31313
	折叠门承重轮铰链	1	31314
	阻尼闭门系统, 带终端限位器	1	31222
	可调节缓冲器, 塑料, 炭黑色	1	31550
	调节工具套装	1	31047
	沉头螺丝, 4.5×16mm, 镀锌 钢, 28件/套	1	31529
	顶部导轨和底部口袋连接器 螺丝	1	31530

推拉款滑轮组套装配件

		编号		
Hawa Folding Concepta III 20/25 Pull, 推拉款滑轮组套装配件, 左		31512		
Hawa Folding Concepta III 20/25 Pull, 推拉款滑轮组套装配件, 右		31513		
		31512	31513	编号
全套配件包括:				
	Folding Concepta III 20/25 Pull, 滑轮装置, 左	1		31004
	推弹装置末端限位支架, 镀锌钢	1	1	31541
	滑轮装置固定器, 塑料, 黑色	1	1	30966
	Folding Concepta III 20/25 Pull, 滑轮装置, 右		1	31046

导轨套装配件, 适用于两门/四门, 氧化铝

	编号
Hawa Folding Concepta III 20/25, 导轨套装配件, 两门, 左, 氧化铝	31514
Hawa Folding Concepta III 20/25, 导轨套装配件, 两门, 右, 氧化铝	31515
Hawa Folding Concepta III 20/25, 导轨套装配件, 四门, 氧化铝	31518

全套配件包括:

	31514	31515	31518	编号
 顶部导轨, 左上角, 氧化铝, 长820mm	1		1	31339
 前导轨, 氧化铝, 长1272mm	1	1		31210
 弧形导轨, 左, 氧化铝	1		1	31365
 底部导轨, 左, 820mm, 氧化铝	1		1	31336
 口袋连接器, 左上角, 长788mm	1		1	31370
 顶部口袋连接器咬合杆, 铝, 长660mm	1	1	2	30977
 底部导轨连接件, 塑料, 黑色, 长94mm	3	3	6	31086
 弧形导轨连接件, 镀锌钢	1	1	2	31543
 顶部导轨支撑件, 塑料, 黑色	1	1	2	31359
 顶部承重轨道适配器, 塑料, 炭黑色, 4件/套	1	1	2	23645
 顶部承重轨道适配器沉头螺丝, 4.5x16mm, 16件/套	1	1	2	31585



续表见下一栏

接上一栏

 顶部导轨, 右上角, 氧化铝, 长820mm	1	1		31340
 弧形导轨, 右, 氧化铝	1	1		31366
 底部导轨, 右, 820mm, 氧化铝	1	1		31337
 口袋连接器, 右上角, 长788mm	1	1		31371
 前导轨, 氧化铝, 长1272mm			1	31343

立柱套装配件, 氧化铝

	编号
Hawa Folding Concepta III 25, 立柱, 高:1900-2700mm, 氧化铝	31520

	31520	编号
 立柱, 适用门板高度1900-2700mm, 氧化铝	1	30771
 门缝装饰盖板, 适用门板高度1900-2700mm, 氧化铝, 长2700mm	1	31232
 盖板固定夹, 2700mm, 塑料, 黑色, 8件/套	1	31503

全套配件包括:

导轨套装配件, 适用于三门系统, 氧化铝

	编号
Hawa Folding Concepta III 20/25, 导轨套装配件, 三门, 左, 氧化铝	31516
Hawa Folding Concepta III 20/25, 导轨套装配件, 三门, 右, 氧化铝	31517

全套配件包括:

	31516	31517	编号
 顶部导轨, 左上角, 氧化铝, 长820mm	1		31339
 前导轨, 氧化铝, 长1954mm	1	1	31341
 弧形导轨, 左, 氧化铝	1		31365
 底部导轨, 左, 820mm, 氧化铝	1		31336
 口袋连接器, 左上角, 长788mm	1		31370
 顶部口袋连接器咬合杆, 铝, 长660mm	1	1	30977
 底部导轨连接件, 塑料, 黑色, 长94mm	3	3	31086
 弧形导轨连接件, 镀锌钢	1	1	31543
 顶部导轨支撑件, 塑料, 黑色	1	1	31359
 顶部承重轨道适配器, 塑料, 炭黑色, 6件/套	1	1	24870
 三门系统专用门板止位器, 适用推拉款和推弹款	1	1	31538
 顶部承重轨道适配器沉头螺丝, 4.5×16mm, 16件/套	1	1	31587

接上一栏

 顶部导轨, 右上角, 氧化铝, 长820mm	1	31340
 弧形导轨, 右, 氧化铝	1	31366
 底部导轨, 右, 820mm, 氧化铝	1	31337
 口袋连接器, 右上角, 长788mm	1	31371

续表见下一栏

导轨套装配件, 适用两门/四门, 氧化铝, 黑色

	编号
Hawa Folding Concepta III 20/25, 导轨套装配件, 两门, 左, 氧化铝, 黑色	31521
Hawa Folding Concepta III 20/25, 导轨套装配件, 两门, 右, 氧化铝, 黑色	31522
Hawa Folding Concepta III 20/25, 导轨套装配件, 四门, 氧化铝, 黑色	31525



全套配件包括:		31521	31522	31525	编号
	顶部导轨, 左上角, 氧化铝, 长820mm	1		1	31339
	前导轨, 氧化铝, 长1272mm	1	1		31211
	弧形导轨, 左, 氧化铝, 黑色	1		1	31367
	底部导轨, 左, 820mm, 氧化铝	1		1	31336
	口袋连接器, 左上角, 长788mm	1		1	31370
	顶部口袋连接器咬合杆, 铝, 长660mm	1	1	2	30977
	底部导轨连接件, 塑料, 黑色, 长94mm	3	3	6	31086
	弧形导轨连接件, 镀锌钢	1	1	2	31543
	顶部导轨支撑件, 塑料, 黑色	1	1	2	31359
	顶部承重轨道适配器, 塑料, 炭黑色, 4件/套	1	1	2	23645
	顶部承重轨道适配器沉头螺丝, 4.5x16mm, 16件/套	1	1	2	31585

接上一栏

	修补笔, 黑色	1	1	1	52117
	顶部导轨, 右上角, 氧化铝, 长820mm		1	1	31340
	弧形导轨, 右, 氧化铝, 黑色		1	1	31368
	底部导轨, 右, 820mm, 氧化铝		1	1	31337
	口袋连接器, 右上角, 长788mm		1	1	31371
	前导轨, 氧化铝, 黑色, 长2539mm			1	31344

立柱套装配件, 氧化铝, 黑色

	编号
Hawa Folding Concepta III 25, 立柱, 高:1900-2700mm, 氧化铝, 黑色	31527

全套配件包括:		31527	编号
	立柱, 适用门板高度1900-2700mm, 氧化铝	1	30771
	门缝装饰盖板, 适用门板高度1900-2700mm, 氧化铝, 黑色, 长2700mm	1	31233
	盖板固定夹, 2700mm, 塑料, 黑色, 8件/套	1	31503

续表见下一栏

导轨套装配件, 适用于三门系统, 氧化铝, 黑色

	编号
Hawa Folding Concepta III 20/25, 导轨套装配件, 三门, 左, 氧化铝, 黑色	31523
Hawa Folding Concepta III 20/25, 导轨套装配件, 三门, 右, 氧化铝, 黑色	31524

全套配件包括:

		31523	31524	编号
	顶部导轨, 左上角, 氧化铝, 长820mm	1		31339
	前导轨, 氧化铝, 黑色, 长1954mm	1	1	31342
	弧形导轨, 左, 氧化铝, 黑色	1		31367
	底部导轨, 左, 820mm, 氧化铝	1		31336
	口袋连接器, 左上角, 长788mm	1		31370
	顶部口袋连接器咬合杆, 铝, 长660mm	1	1	30977
	底部导轨连接件, 塑料, 黑色, 长94mm	3	3	31086
	弧形导轨连接件, 镀锌钢	1	1	31543
	顶部导轨支撑件, 塑料, 黑色	1	1	31359
	顶部承重轨道适配器, 塑料, 炭黑色, 6件/套	1	1	24870
	三门系统专用门板止位器, 适用推拉款和推弹款	1	1	31538
	顶部承重轨道适配器沉头螺丝, 4.5x16mm, 16件/套	1	1	31587

接上一栏

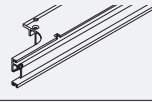
	修补笔, 黑色	1	1	52117
	顶部导轨, 右上角, 氧化铝, 长820mm		1	31340
	弧形导轨, 右, 氧化铝, 黑色		1	31368
	底部导轨, 右, 820mm, 氧化铝		1	31337
	口袋连接器, 右上角, 长788mm		1	31371

续表见下一栏



加固配件

		编号
	加固配件, 2765mm, 适用四门, 氧化铝	52109
	加固配件, 2085mm, 适用三门, 氧化铝	52110

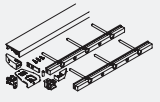
底座配件

		编号
	底座配件套装, 两门, 氧化铝	52089
	底座配件套装, 三门, 氧化铝	52090
	底座配件套装, 四门, 氧化铝	52091
	底座配件套装, 两门, 氧化铝, 黑色	52092
	底座配件套装, 三门, 氧化铝, 黑色	52093
	底座配件套装, 四门, 氧化铝, 黑色	52094

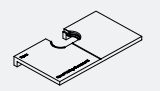
选装配件

		编号
	折叠门铰链开孔模具	52121
	门板找平装置(带磁性), 带钻孔模板, 氧化铝	24006

门板拉直器

→ 在第323页的附件中查找详细信息

铝, 未经处理

		编号
	门板拉直器, 2040-2600mm, 铝	056.3192.072
	门板拉直器, 1715-2275mm, 铝	056.3192.079

氧化铝

		编号
	门板拉直器, 2240-2850mm, 氧化铝	056.3192.071
	门板拉直器, 2040-2600mm, 氧化铝	056.3192.082

氧化铝, 黑色

		编号
	门板拉直器, 2240-2850mm, 氧化铝, 黑色	056.3192.074
	门板拉直器, 2040-2600mm, 氧化铝, 黑色	056.3192.075
	门板拉直器, 1715-2275mm, 氧化铝, 黑色	056.3192.081

门板拉直器

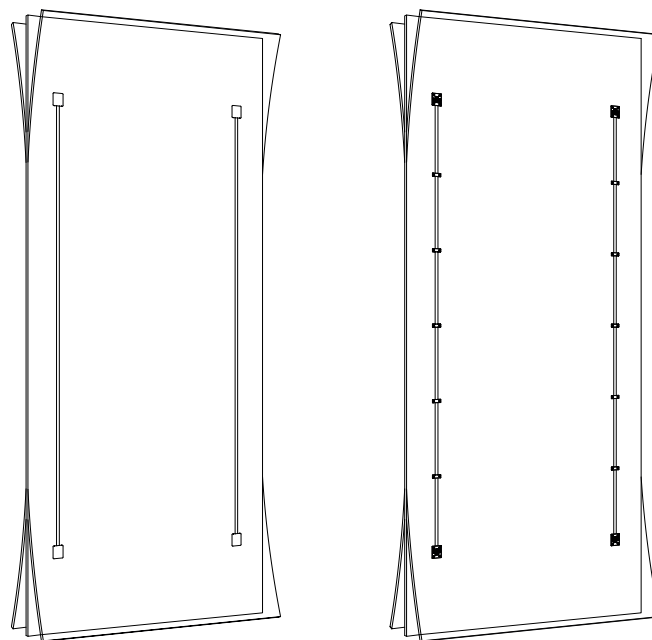

更多安装示例
两门/四门系统外盖门, 带底座型材

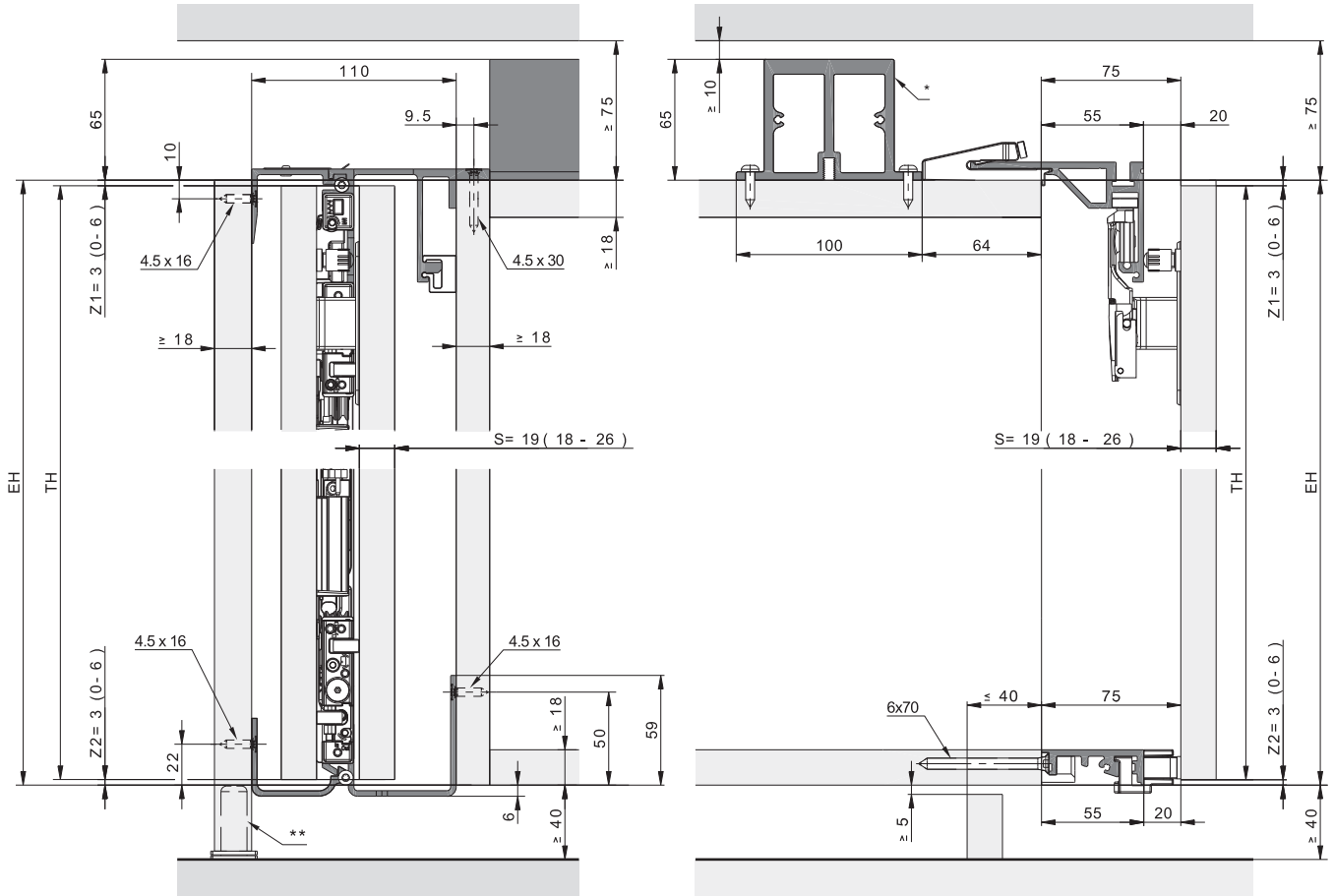

- * 加固配件适用于无中竖板的三门和四门系统
- ** 建议: 使用调节脚

一门到顶无底板
两门/四门系统

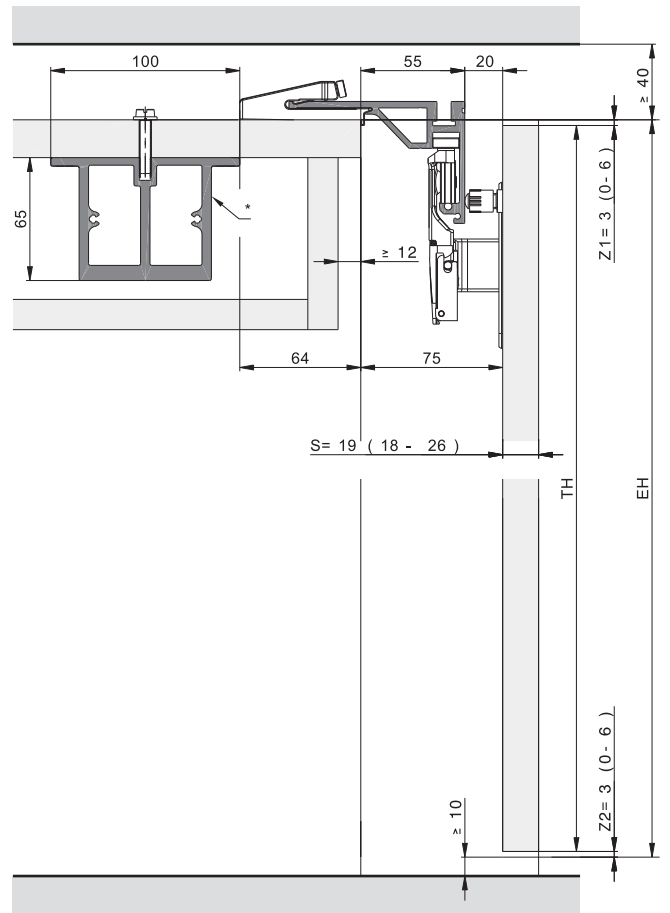
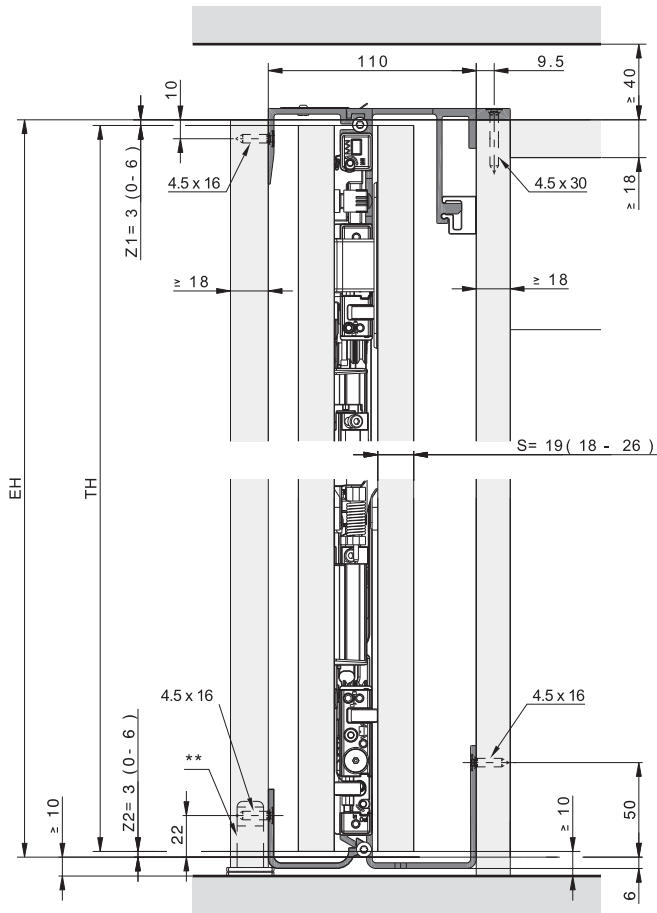

- * 加固配件适用于无中竖板的三门和四门系统
- ** 建议:使用调节脚

三门系统外盖门, 无底座型材

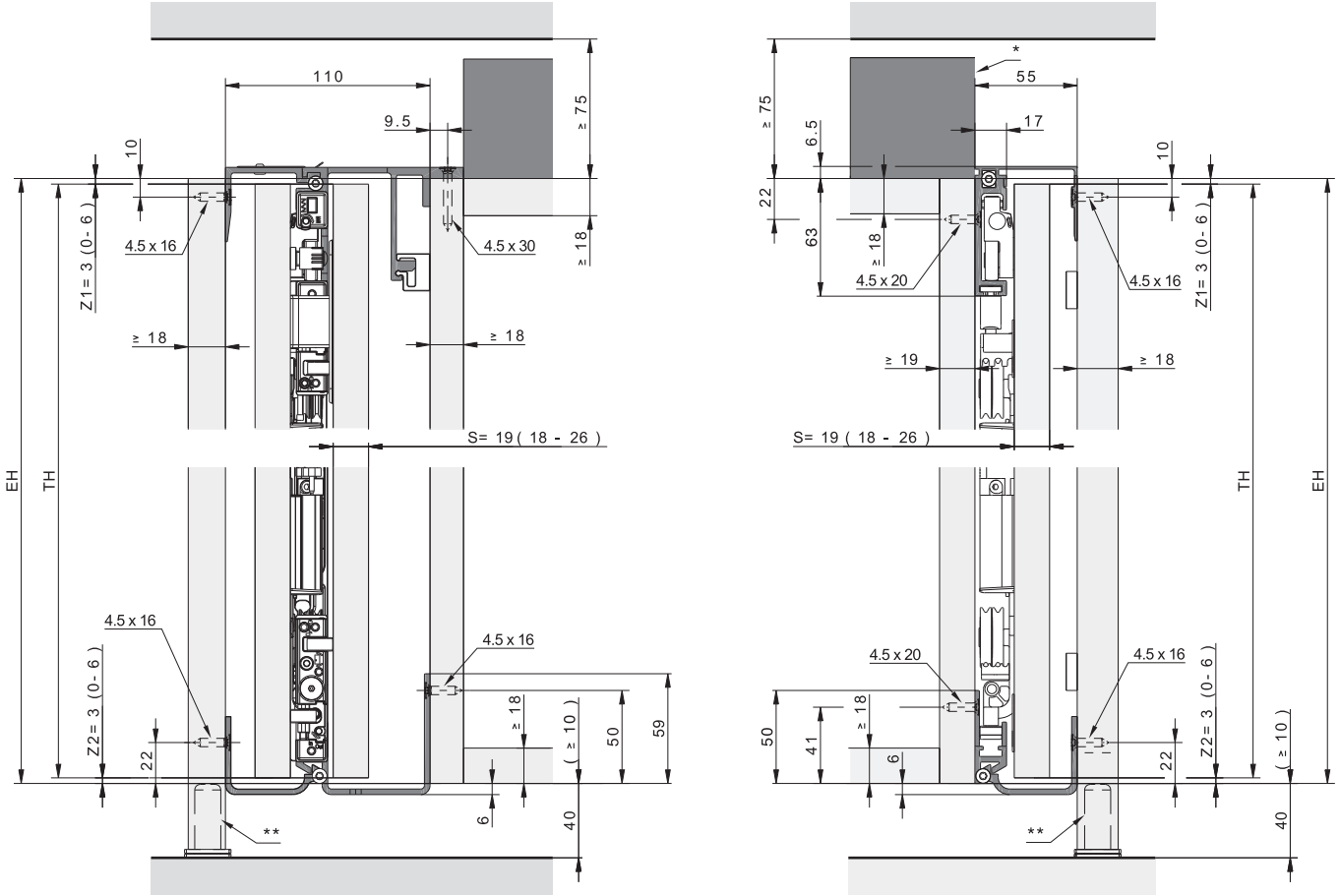

- * 加固配件适用于无中竖板的三门和四门系统
- ** 建议: 使用调节脚

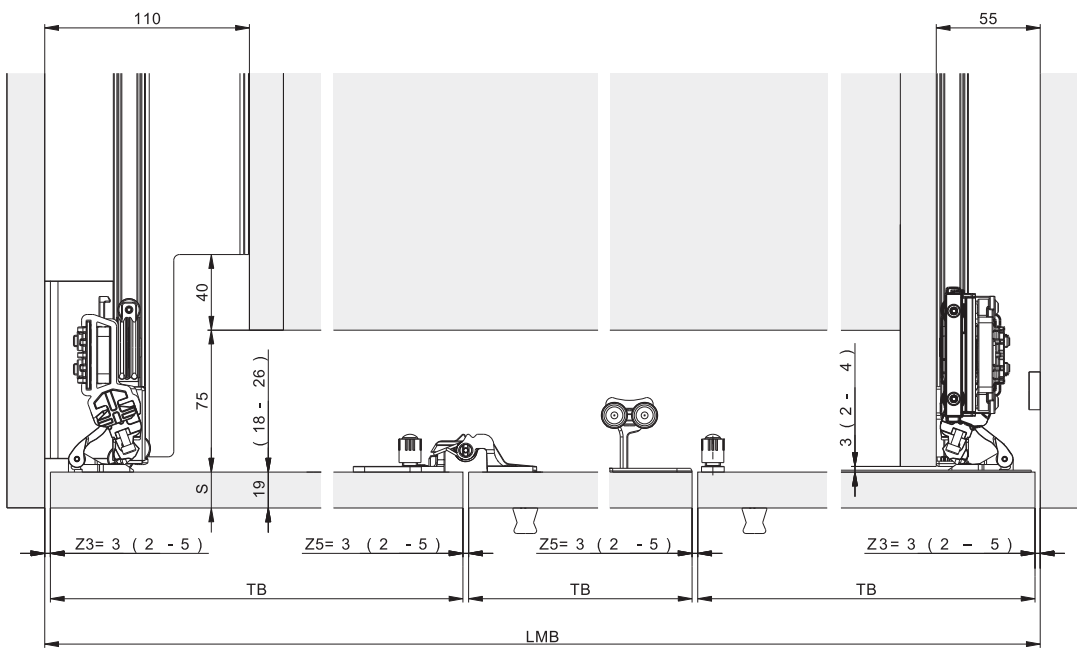

安装深度计算
门板平外侧板

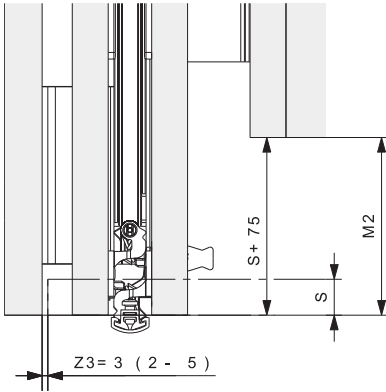

门板凸出外侧板

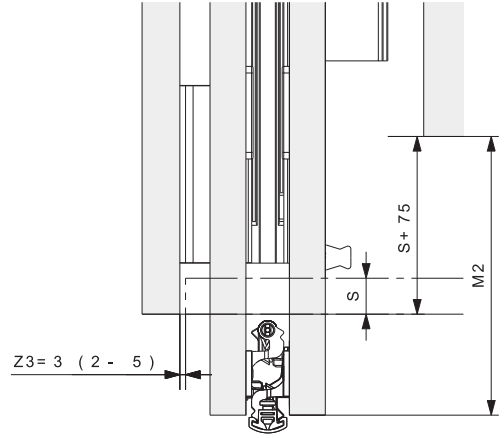

	mm
T2	$TB + 92 + Z3 - M2$
E2	$TB - M2$
KT2	$\geq T2$
M2	$\geq S + 75$ $\leq TB - 390$

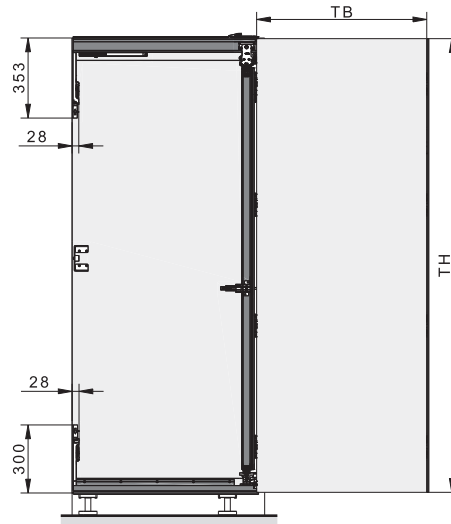
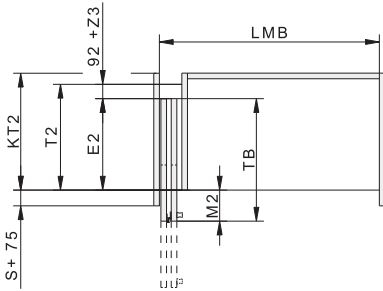

- S = 门板厚度
- Z = 门缝
- E2 = 可推入深度
- T2 = 配件深度
- TB = 门板宽度
- TH = 门板高度
- KT2 = 柜体深度
- LMB = 柜体净宽
- M2 = 门板凸出柜体距离

在线访问

如需了解最新的旋转门、折叠门或推拉门的五金件, 请访问网站
hawa.com/concepta3-familie。

我们将竭诚为你服务。如要联系我们, 请访问网站info@hawa.com, 或者
致电+41 44 787 17 17